

FMI 3-04.155
April 2006
Expires April 2008

ARMY UNMANNED AIRCRAFT SYSTEM OPERATIONS

HEADQUARTERS, DEPARTMENT OF THE ARMY

Distribution Restriction-Approved for public release; distribution is unlimited.

**This publication is available at Army
Knowledge Online <www.us.army.mil>
and the General Dennis J. Reimer Training and
Doctrine Digital Library at <www.train.army.mil>.**

ARMY UNMANNED AIRCRAFT SYSTEM OPERATIONS

Contents

		Page
	PREFACE	v
Chapter 1	ORGANIZATION, MISSIONS, AND FUNDAMENTALS.....	1-1
	Section I –General	1-1
	Unmanned aircraft system Types.....	1-1
	Organization	1-1
	Mission	1-2
	Capabilities	1-2
	Limitations	1-2
	Fundamentals.....	1-3
	Echelons of Support	1-4
	Section II–Unmanned Aircraft System Organizations.....	1-6
	RQ-1L I-Gnat Organization	1-6
	RQ-5/MQ-5 Hunter Aerial Reconnaissance Company	1-7
	RQ-7 Shadow Aerial Reconnaissance Platoon	1-8
	RQ-11 Raven Team	1-9
	Section III–Duty Descriptions and Responsibilities	1-10
	Company Commander	1-10
	Platoon Leader	1-10
	Unmanned aircraft system Operations Officer (150U).....	1-11
	First Sergeant.....	1-11
	Platoon Sergeant.....	1-11
	Air Mission Commander	1-12
	Unmanned aircraft system Operator (15W)	1-12
	External Pilot (RQ-5/MQ-5 Hunter Only).....	1-12
	Unmanned Aerial System Operator (RQ-11 Raven).....	1-12

Chapter 2	ARMY UNMANNED AERIAL SYSTEMS.....	2-1
	RQ-1L I-Gnat.....	2-1
	RQ-5/MQ-5 Hunter.....	2-3
	RQ-7 Shadow.....	2-6
	RQ-11 Raven.....	2-10
Chapter 3	JOINT UNMANNED AERIAL SYSTEMS.....	3-1
	Section I–Joint UAS Request Procedures.....	3-1
	Joint Command Architecture.....	3-1
	Unmanned aircraft system Support.....	3-2
	Section II–Air Force.....	3-4
	RQ-4 Global Hawk.....	3-4
	RQ/MQ-1 Predator.....	3-6
	MQ-9 Predator B.....	3-8
	Force Protection Aerial Surveillance System–Desert Hawk.....	3-10
	Section III–Navy.....	3-12
	RQ-2 Pioneer.....	3-12
	RQ-8B Fire Scout.....	3-13
	Section IV–Marine Corps.....	3-14
	FQM-151 Pointer.....	3-14
	Dragon Eye.....	3-15
	Silver Fox.....	3-16
	Scan Eagle.....	3-17
	Section V–Coast Guard.....	3-19
	Eagle Eye.....	3-19
	Section VI–Special Operations Command.....	3-20
	CQ-10 SnowGoose.....	3-20
	FQM-151 Pointer.....	3-21
	RQ-11 Raven.....	3-22
	Dragon Eye.....	3-23
Chapter 4	UNMANNED AERIAL SYSTEMS MISSION PLANNING CONSIDERATIONS	4-1
	Section I–Overview.....	4-1
	Section II–Employment Considerations.....	4-2
	Location of Unmanned aircraft systems.....	4-2
	Sustained Operations.....	4-4
	Terrain and Weather.....	4-4
	Sensor Considerations.....	4-5
	Threat Considerations.....	4-6
	Time/Resources Available.....	4-7
	Dynamic Retasking.....	4-8
	Civil Considerations (Combat Operations).....	4-9
	Section III–Mission Planning Process.....	4-9
	Mission Supported Unit.....	4-9
	Echelons Above Brigade Combat Team Tasking and Planning.....	4-10
	Brigade and Below Planning Responsibilities.....	4-11
	Brigade and Below Tasking/Planning.....	4-11

	Unmanned aircraft system Unit Planning Process.....	4-13
	Post Mission Actions	4-17
	Section IV–Army Airspace Command and Control.....	4-17
	Section V–Command and Control	4-19
	Levels of Interoperability	4-19
	Communications.....	4-21
	Using a Remote Video Terminal	4-22
	Section VI–Risk Mitigation	4-23
	Safety.....	4-23
	Risk Management.....	4-24
	Unmanned aircraft system Safety Considerations	4-25
Chapter 5	UNMANNED AERIAL SYSTEMS EMPLOYMENT	5-1
	Section I–Reconnaissance and Surveillance	5-1
	Reconnaissance	5-1
	Unmanned aircraft system Reconnaissance Fundamentals	5-2
	Actions on the Objective.....	5-4
	Data Exfiltration	5-4
	Surveillance	5-5
	Section II–Security Operations	5-6
	Screen	5-6
	Guard and Cover Operations	5-10
	Section III–Unmanned Aircraft System Targeting.....	5-12
	Facilitate Targeting	5-12
	Precision of Target Locations.....	5-13
	Facilitate Command and Control.....	5-14
	Facilitate Movement	5-14
	Section IV–Manned-Unmanned Team Operations	5-15
	Manned-Unmanned Team Missions	5-15
	Reconnaissance, Surveillance, and Target Acquisition Missions.....	5-18
	Screen Missions	5-19
	Movement to Contact	5-23
	Aerial Target Designation.....	5-23
	Artillery Fire Support.....	5-25
	Close Air Support	5-26
	Kill Box.....	5-27
	Section V–Personnel Recovery	5-29
	Mission Execution.....	5-30
Chapter 6	SUSTAINMENT OPERATIONS.....	6-1
	Section I–General	6-1
	Logistics.....	6-1
	Maintenance	6-2
	Section II–Unmanned Aircraft System Organizations	6-3
	RQ-1L I-Gnat	6-3
	RQ-5/MQ-5 Hunter	6-3
	RQ-7 Shadow	6-4

Contents

RQ-11 Raven 6-4

**Appendix A ARMY UNMANNED AERIAL SYSTEMS MISSION PLANNING AND FLIGHT
CHECKLISTS A-1**

**Appendix B EXTRACT FROM LEADER’S GUIDE TO ARMY AIRSPACE COMMAND AND
CONTROL AT BRIGADE AND BELOW B-1**

Appendix C TRAINING CONSIDERATIONS C-1

**Appendix D ARMY UNMANNED AERIAL SYSTEM CONTRIBUTIONS TO
JOINT OPERATIONS D-1**

Appendix E RECOVERY OF UNMANNED AERIAL VEHICLES E-1

GLOSSARY Glossary-1

REFERENCES References-1

INDEX Index-1

Preface

Field manual interim (FMI) 3-04.155 is the Army's keystone doctrine for how to fight and sustain Army Unmanned Aircraft Systems (UAS). The doctrinal basis for operational concepts described in this manual are established in field manual (FM) 1, FM 3-0, and FM 3-04.111. FMI 3-04.155 provides overarching doctrinal guidance for employing Army UAS in full spectrum operations and is in synchronization with joint doctrine. It provides a foundation for the development of tactics, techniques, and procedures (TTP) in other and follow-on Army manuals. Emphasis is placed on force structure and the enhanced operational capability provided by UAS.

FMI 3-04.155, the Army's overarching UAS manual, provides unit leaders and their staff officers and noncommissioned officers (NCOs) with the knowledge necessary to properly plan for and execute the integration of Army UAS into combined arms operations. This is the Army's principal tool to assist Army branch schools in teaching UAS operations. Army schools and centers will incorporate the concepts and requirements in this document into their doctrinal manuals and professional military education literature as appropriate. This manual will also inform joint, multinational, and coalition forces of the capabilities and procedures for using the Army UAS in joint and multinational operations.

UAS support operations throughout the U.S. Army, as well as joint, interagency, and multinational (JIM) operations across the full spectrum of conflict. UAS organizations conduct combat operations throughout the depth and breadth of the battlefield and will eventually exist at multiple echelons within the Army. Although the organization and composition of JIM UAS are different by echelon and service, their employment and principal focus are similar to Army UAS operations.

Chapter 1 focuses on UAS organizations, missions, and fundamentals. Chapter 2 provides an overview of Army UAS and system descriptions and capabilities. Chapter 3 provides an overview of joint UAS and the capabilities they give the maneuver commander. Chapter 4 discusses UAS planning considerations all users must be familiar with for the successful execution of UAS operations. Chapter 5 discusses employment of the UAS. Chapter 6 discusses sustainment requirements and considerations for UAS operations at all echelons. Appendix A provides checklist for planning and coordinating UAS operations. Appendix B details planning for the integration of Small UAS into airspace coordination. Appendix C gives UAS commanders an overview of training responsibilities and requirements. Appendix D provides joint users with information to obtain Army UAS support. Appendix E gives guidance for recovering downed unmanned aircraft.

This FMI applies to the transformation force across the full spectrum of military operations.

FMI 3-04.155 specifically addresses UAS operations; refer to the appropriate chapter/appendix of FM 3-04.111 for guidance in other aviation related areas.

This publication applies to the Active Army, the Army National Guard (ARNG)/Army National Guard of the United States (ARNGUS), and the United States Army Reserve (USAR) unless otherwise stated. It builds on the collective knowledge and experience gained through recent combat and training operations, numerous field and simulation exercises, and the deliberate process of informed reasoning. This publication is rooted in time-tested principles and fundamentals, while accommodating new technologies and evolving responses to the diverse threats to national security.

Finally, FMI 3-04.155 furnishes a foundation for UAS doctrine, force design, materiel acquisition, professional education, and individual and unit training.

The proponent for this manual is the United States Army Training and Doctrine Command (TRADOC). The preparing agency is the United States Army Aviation Warfighting Center (USAAWC). Send comments and

recommendations using Department of the Army (DA) Form 2028 (*Recommended Changes to Publications and Blank Forms*) to Commander, USAAWC, ATTN: ATZQ-TD-D, Fort Rucker, AL 36362, or email at av.doctrine@us.army.mil. Other doctrinal information can be found on Army Knowledge Online or call defense switch network (DSN) 558-3011 or (334) 255-3011.

The acronym UAS refers to the system as a whole (unmanned aircraft [UA], payload, and all direct support equipment). Direct support equipment includes the ground control station (GCS), ground data terminal (GDT), launch and recovery (L/R) system, transport and logistics vehicles, operators and maintainers, unit leadership, and others. The acronym UA refers to the unmanned aircraft exclusively and does not include the payload unless stated otherwise.

Chapter 1

Organization, Mission, and Fundamentals

UAS operations support battlefield commanders and their staffs as they plan, coordinate, and execute operations. UAS increase the situational awareness (SA) of commanders through intelligence, surveillance, and reconnaissance (ISR). Armed UAS provide commanders direct fire capabilities to prosecute the close fight and influence shaping of the battlefield. Army UAS can perform some or all of the following functions: enhanced targeting through acquisition, detection, designation, suppression and destruction of enemy targets, and battle damage assessment (BDA). Other UAS missions support the maneuver commander by contributing to the effective tactical operations of smaller units. GCSs with common data links, remote video terminals (RVTs) and remote operations video enhanced receiver (ROVER), portable ground control stations (PGCSs), and Army helicopter/Army airborne command and control system (A2C2S)/UA teaming will enhance SA and the common operational picture (COP), helping to set the conditions for the current and future forces (FF's) success.

SECTION I –GENERAL

UNMANNED AIRCRAFT SYSTEM TYPES

- 1-1. The four different types of UAS the Army uses to conduct operations are—
 - Improved–Gnat (I-Gnat) (RQ-1L).
 - Hunter (RQ-5/MQ-5).
 - Shadow (RQ-7).
 - Raven (RQ-11).
- 1-2. The Department of Defense (DOD) has an alphanumeric designation for UAS. The letter designation includes the following:
 - C—designation for cargo.
 - R—designation for reconnaissance.
 - M—designation for multi-role.
 - Q—designation for unmanned aircraft system.
- 1-3. The number refers to the system's position when it entered the series of purpose-built unmanned aircraft systems. For example, RQ-7 (Shadow) is the seventh reconnaissance unmanned aircraft system in the UAS series.

ORGANIZATION

- 1-4. Each UAS organization is diverse in form and functions with different capabilities and limitations based upon the specific echelon and UAS they employ. However, each UAS organization is structured to

effectively conduct reconnaissance, surveillance, target acquisition (TA), attack (when equipped), and BDA.

MISSION

1-5. UAS are capable of locating and recognizing major enemy forces, moving vehicles, weapons systems, and other targets that contrast with their surroundings. In addition, UAS are capable of locating and confirming the position of friendly forces, presence of noncombatant civilians, and so forth. Current Army UAS missions include—

- Reconnaissance.
- Surveillance.
- Security.
- Manned-Unmanned Teaming.
- Communications Relay.

CAPABILITIES

1-6. UAS currently bring numerous capabilities to Army units, providing NRT reconnaissance, surveillance, and TA. They can be employed on the forward line of own troops (FLOT), on the flanks, or in rear areas. Employed as a team, UAS and manned systems provide excellent reconnaissance and attack resolution. Some UA can be fitted with laser designators to mark targets and others may be armed. Other capabilities currently provided are as follows:

- Support TA efforts and lethal attacks on enemy reconnaissance and advance forces.
- Assist in route, area, and zone reconnaissance.
- Locate and help determine enemy force composition, disposition, and activity.
- Maintain contact with enemy forces from initial contact through BDA.
- Provide target coordinates with enough accuracy to enable an immediate target handover, as well as first-round fire-for-effect engagements.
- Provide or enhance multispectrum sensor coverage of the AO.
- Provide information to manned systems, thus increasing survivability.
- Reduce or eliminate exposure time of manned systems in high-risk environments.
- Provide extended three-dimensional vantage, both in distance and time, at critical decision points (DPs) in difficult terrain.
- Perform decoy, demonstration, feint, and deception operations.
- Support mission duration beyond those of manned systems.
- Provide digital connectivity, allowing for rapid product dissemination.

1-7. The following are capabilities unique to the RQ-11 Raven:

- Attritable.
- Day and night imagery/Operations.
- Low noise signature.
- Portable.
- Interchangeable payloads and components.
- Mobile launch capable.

LIMITATIONS

1-8. While UAS are an excellent force multiplier, they have limited effectiveness in locating enemy forces that are well covered or concealed. Tactical UA, such as Shadow and Raven, are not well suited for

wide area searches. Rather, employing UA as part of an overall collection plan takes advantage of their capabilities. Other limitations include—

- Vulnerability to enemy fire.
- Weather restrictions (cloud cover, turbulence, and others).
- Must maintain LOS to ground control stations.
- Limited frequencies for UAS control.
- A2C2 issues.
- Limited sensor field of view.
- Limited detection capability in highly vegetated areas.
- Unique Class III/V Requirements.
- Assembly Area survivability.

1-9. The following are limitations unique to the RQ-11 Raven:

- Zero wind—Increases difficulty of launch. Consider using mounted launch or launch from atop building or terrain.
- Winds less than 20 knots—Decreases system endurance from increased battery use and can cause uncommanded altitude deviations.
- Extreme Heat and Cold—Reduces endurance (battery life) and degrades system performance. Overheating can cause GCU failure.
- Night front- or side-look camera only.
- Fragile Components.

FUNDAMENTALS

1-10. UAS play an integral role in the accomplishment of each of the warfighter functions. An in-depth discussion of these roles will occur in later chapters of this manual.

- Intelligence.
- Maneuver.
- Fire support (FS).
- Air defense (AD).
- Mobility/countermobility/survivability.
- Sustainment.
- Command and control (C2).

1-11. All UAS organizations must be able to—

- Plan and conduct strategic deployment.
- Conduct administrative and tactical movements.
- Coordinate with supported maneuver units.
- Gather information to support the intelligence preparation of the battlefield (IPB).
- Use the full spectrum of communications means to satisfy internal and external requirements for combat information.

- 1-12. All UAS organizations must accomplish operations under any of the following conditions:
- As a subordinate unit assigned, attached, operational control, or tactical control (TACON) to another service.
 - Near ground forces.
 - Day or night.
 - Densely populated controlled and uncontrolled airspace.
 - Chemical, biological, radiological, and nuclear (CBRN)—avoid intentional contamination.
 - All types of environments, including desert, mountainous, rolling hills, dense forest, jungle, plains, and urban.
 - All operational environments, including contiguous, noncontiguous, linear, nonlinear, and asymmetrical.
- 1-13. Each UAS organization must be proficient in the following areas:
- Attack operations (if applicable).
 - Call-for-fire operations.
 - Reconnaissance and security operations.
 - Terrain flight: low-level, contour, and nap-of-the-earth—Raven only.
 - Emergency procedures.
 - Base defense (includes emergency evacuation under all weather conditions).
 - CBRN exposure avoidance, surveys, and decontamination.
 - Other basic tactical skills (mission training plans [MTPs], aircrew training manuals [ATMs], soldier training publications [STPs], and others).
 - Army airspace command and control (A2C2).
 - Risk assessment.

ECHELONS OF SUPPORT

- 1-14. UAS provide three echelons of support.

BRIGADE COMBAT TEAM AND BELOW

- 1-15. Primarily the realm of the Raven, UAS in this echelon are characterized by close range (less than 25 kilometers), short duration missions (1 to 2 hours) operating below the coordinating altitude and thoroughly integrating with the ground forces normally in a direct support (DS) role (figure 1-1).

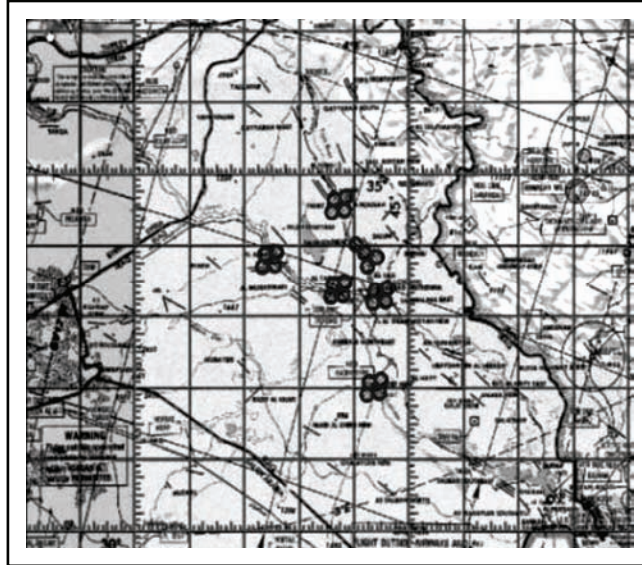

Figure 1-1. Brigade combat team (BCT) and below coverage

BRIGADE COMBAT TEAM - DIVISION

1-16. As the brigade combat team (BCT) organic asset, the RQ-7 Shadow is typical for this echelon of support. Increasing in complexity (general support [GS] and (or) DS), with longer duration (4+ hours) and range (less than 125 kilometers), the RQ-7 Shadow operates above the coordinating altitude and provides coverage for multiple sectors and ground units (figure 1-2).

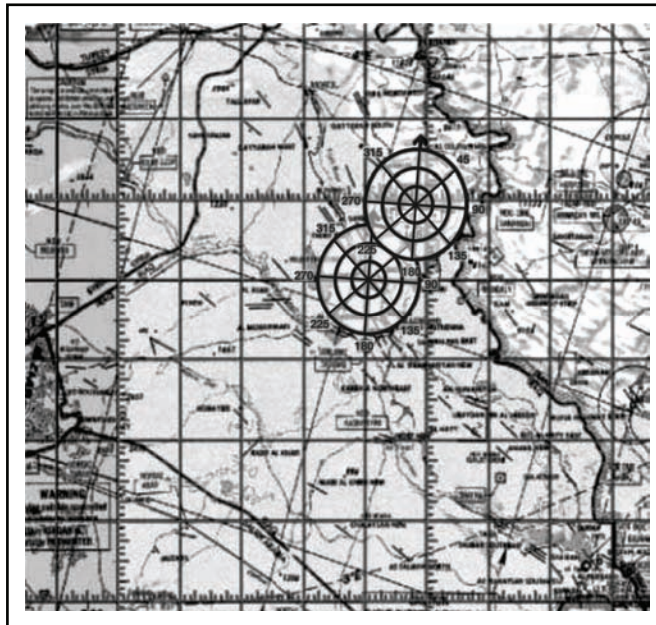

Figure 1-2. BCT to division coverage

DIVISION AND ABOVE

1-17. Medium endurance (16+ hours), extended range (200+ kilometers) UAS conduct operations at this echelon similarly to the previous level. Primarily in a GS role, these larger platforms bring multiple payloads (RQ-1L Army I-Gnat) and strike capability (MQ-5B Hunter and RQ-1L Army I-Gnat) to their supported units. The concentric rings represent coverage for the upgraded non-line of sight satellite communications I-Gnat (figure 1-3).

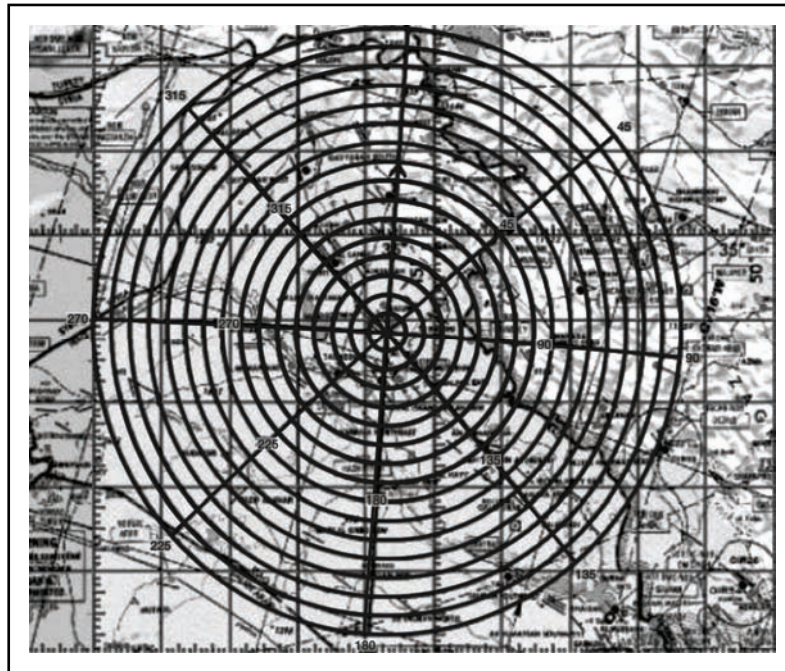

Figure 1-3. Upgraded I-Gnat division and above coverage

SECTION II—UNMANNED AIRCRAFT SYSTEM ORGANIZATIONS

RQ-1L I-GNAT ORGANIZATION

ORGANIZATION

1-18. The I-Gnat organization is operated by a contractor team and is not a formal Army program. It has—

- Three UA.
- Two antennas (portable ground data terminal and GDT).
- One mobile ground control station mounted on a high mobility multipurpose wheeled vehicle (HMMWV).
- Ground support equipment (GSE).

MISSION

1-19. The mission of the I-Gnat unit is to provide a real-time, responsive day and night ISR capability to support SA, TA, and BDA.

FUNDAMENTALS

1-20. The I-Gnat unit operates at the corps level, but may be allocated to support a subordinate division's scheme of maneuver. A deployed I-Gnat UA conducts ISR missions to protect friendly forces. The I-Gnat UA is capable of moving quickly (160 knots dash speed) to provide reconnaissance and security, and to employ indirect fires. I-Gnat can perform real-time BDA. I-Gnat has a dual payload (Lynx SAR) and is kinetic effect (air-launched guided missile [AGM]-114K Hellfire) capable.

RQ-5/MQ-5 HUNTER AERIAL RECONNAISSANCE COMPANY

ORGANIZATION

1-21. The aerial reconnaissance company organization consists of (figure 1-4)—

- Forty-eight military (4/2/42) and 5 contractor logistic support (CLS) personnel. These personnel are divided between the—
 - Headquarters platoon.
 - Aerial reconnaissance support section.
 - Two aerial reconnaissance platoons.
 - Maintenance section (production control, armament personnel and CLS).
- Six medium altitude, long endurance UA (currently MQ-5B Hunter).
- Six HMMWVs (also known as a Humvee) and trailers.
- Three vehicle mounted GCSs with trailer mounted generators.
- Two GDTs.
- Two 5-ton trucks with trailers.
- One 5-ton truck with crane and fuel trailer.
- One 5-ton truck with tank and pump unit.

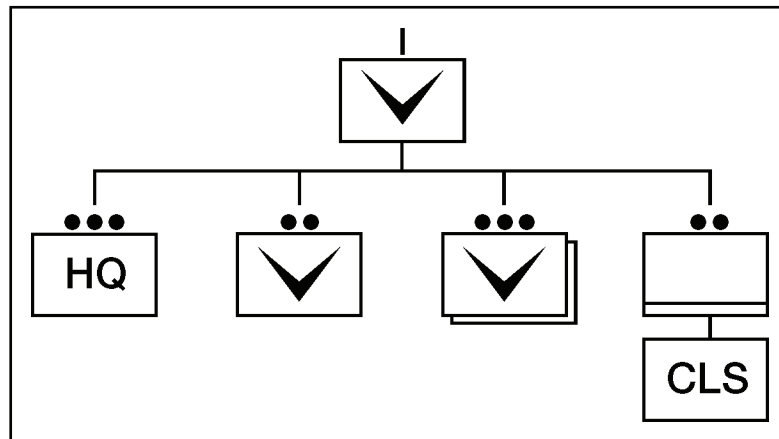

Figure 1-4. Aerial reconnaissance company

1-22. Units should review the current modified table of organization and equipment (MTOE) for each unit because differences may exist as new equipment arrives and replaces older equipment.

MISSION

1-23. The mission of the aerial reconnaissance company is to provide a real-time, responsive day and night ISR capability to support SA, TA, attack targets (autonomous and (or) remote engagements), and BDA.

FUNDAMENTALS

1-24. The aerial reconnaissance company operates at the corps level but may be allocated to support a subordinate unit's scheme of maneuver. Aerial reconnaissance company UA can conduct the same breadth of missions as shadow platoons. The additional capability gained through armed UA allows the company to perform screen missions and participate in guard or cover missions either as an aerial fire controller or in the direct attack role.

1-25. The modular organization of the aerial reconnaissance company facilitates the integration of nonstandard contractor-operated UAS (such as the RQ-11L I-Gnat) or additional detachments of other service UAS.

1-26. The aerial reconnaissance company is not capable of independent operations. It requires external administrative and logistical support and has minimal self-defense capability.

RQ-7 SHADOW AERIAL RECONNAISSANCE PLATOON

ORGANIZATION

1-27. The aerial reconnaissance platoon consists of (figure 1-5)—

- Twenty-two military personnel (1/1/20) and 2 CLS personnel. These personnel are divided into the—
 - Flight operations section.
 - Maintenance section and CLS.
- Four UA.
- Four RVTs.
- Two vehicle mounted GCSs.
- Two GDTs.
- Two personnel/equipment transport vehicles with one equipment trailer.
- Two tactical automated landing systems (TALSs).
- One vehicle mounted air vehicle transport (AVT) with launcher trailer.
- One vehicle mounted mobile maintenance facility with maintenance trailer.
- One portable GCS.
- One portable GDT.

1-28. Units should review the current MTOE for each unit because differences may exist as new equipment arrives and replaces older equipment.

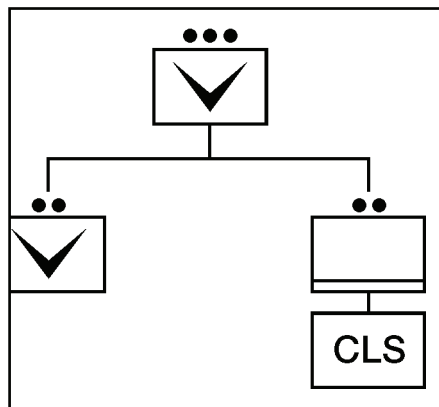

Figure 1-5. Shadow platoon

MISSION

1-29. The mission of the aerial reconnaissance platoon is to provide a real-time, responsive day and night imagery surveillance and reconnaissance capability to support SA, TA, and BDA to brigade and below units.

FUNDAMENTALS

1-30. The aerial reconnaissance platoon operates at the brigade level (organized under squadron level within the Stryker brigade combat team [SBCT], reference special text (ST)/FM 2-19-602/3-20.972), but may be allocated to support a subordinate battalion. UAS can deploy to conduct ISR missions to protect friendly forces. The aerial reconnaissance platoon can perform screen missions and participate in guard or cover missions. The UAS provides reconnaissance and security and (or) employ indirect fires. UAS can perform near real-time (NRT) BDA.

RQ-11 RAVEN TEAM

ORGANIZATION

1-31. A Raven team typically consists of (figure 1-6)—

- Two operators from the unit assigned the equipment.
- Three UA.
- Three payload types.
 - EO front and side look (quantity of three).
 - IR front look (quantity of two).
 - IR side look (quantity of two).
- One ground control unit (GCU).
- RVT.
- Batteries (rechargeable).
- Carry/protective cases.
- Battery charger/power supply.

- Field maintenance kit.
- Spares and repair parts.

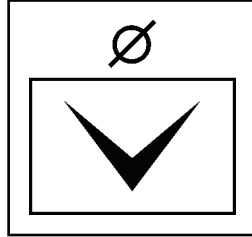

Figure 1-6. Raven team

MISSION

1-32. The mission of the Raven team is to provide reconnaissance and surveillance (R&S) and remote monitoring day and night imagery to support SA, TA, and BDA.

FUNDAMENTALS

1-33. The Raven team operates at the company level. Raven UA deploy to conduct R&S missions and convoy security to protect friendly forces. The Raven UA travels at 25 to 60 knots to provide information on enemy location, disposition, activity, and (or) employ indirect fires. Raven can perform real-time BDA.

SECTION III—DUTY DESCRIPTIONS AND RESPONSIBILITIES

1-34. UAS personnel perform crucial roles in the preparation, execution, and support of UAS operations. Not all UAS units have all the military occupational specialties (MOSs) listed below.

COMPANY COMMANDER

1-35. The company commander is responsible for everything the unit does or fails to do. The commander's main concerns are to accomplish the mission and ensure the welfare of the Soldiers. Commanders must have an in-depth knowledge of enemy forces and how they fight, and a technically and tactically proficiency in UAS employment. The commander is also responsible for ensuring airspace coordination and deconfliction tasks are accomplished.

PLATOON LEADER

1-36. During planning, recovery, and assembly area (AA) operations, the platoon leader's role focuses on preparation for the next mission. The platoon leader—

- Leads the platoon.
- Manages platoon training.
- Ensures each platoon member prepares for the mission.
- Monitors fighter management status of platoon members.
- Coordinates with the maintenance officer and platoon sergeant to verify UA status and monitors the maintenance effort.
- Supervises unit movements.
- Advises the commander on platoon issues such as UAS maintenance, personnel status, and support requirements.

UNMANNED AIRCRAFT SYSTEM OPERATIONS OFFICER (150U)

1-37. The UAS operations officer (MOS 150U) may act as the mission commander (MC) (if Army regulation [AR] 95-23 requirements are met), team leader, and when required, platoon leader. He develops UAS requirements and identifies appropriate payloads to satisfy the collection requirements for each mission and acts as the commander's advisor on employment of the UAS, payload/sensors, and weapons, recommending appropriate TTP for each mission. He is responsible for ensuring UAS operators adhere to standardization and safety programs by having UAS crews adhere to mission briefing parameters, including airspace deconfliction as directed by ATC and the air tasking order (ATO). The operations officer also handles tactical, administrative, and logistics interface with supported units.

FIRST SERGEANT

1-38. The first sergeant (1SG) acts on the commander's behalf when dealing with other NCOs in the unit. In addition, the 1SG is the commander's primary advisor concerning enlisted soldiers. The 1SG focuses unit attention on any function critical to success of the mission. Additionally, the 1SG is one of the principal trainers for assigned enlisted personnel. The 1SG assists the commander in the following ways:

- Monitors NCO development, promotions, and assignments.
- Identifies, plans, and assesses Soldier training.
- Monitors morale of the company.
- Provides recommendations and expedites the procurement and preparation of enlisted replacements for the company.
- Coordinates medical, mess, supply, administrative, and other logistics support.
- Conducts informal investigations.
- Leads ground movements when required.
- Mentors, guides, and inspires the leaders and Soldiers.
- Manages platoon training.
- Commands and controls assigned assets.
- Accomplishes assigned missions.
- Is familiar with all aspects of the UAS.
- Preserves the combat power of the force.

PLATOON SERGEANT

1-39. The platoon sergeant (PSG) acts on the platoon leader's behalf when dealing with other NCOs in the unit and is the platoon leader's primary advisor concerning enlisted soldiers. The PSG assists the platoon leader in the following ways:

- Commands and controls assigned assets.
- Focuses unit attention on functions critical to mission success.
- Accomplishes assigned missions.
- Leads ground movements when required.
- Has the responsibility for tactical employment of the platoon.
- Is familiar with all aspects of the UAS.
- Preserves the combat power of the force.
- Identifies, plans, and assesses Soldier training.
- Can be qualified as an instructor pilot (IP) and assist the standardization pilot (SP) in the management and enforcement of the Army's UAS Standardization Program.

AIR MISSION COMMANDER

1-40. The air mission commander (AMC) is responsible for planning, briefing, and executing the mission as received in the daily flight schedule, ATO and advisory tasking. The AMC, empowered by the chain of command, makes decisions and takes immediate corrective action to prevent injury, accident, or damage to equipment. The AMC is responsible for the safe conduct of all flight operations, including ground operations. The AMC is appointed in writing by the commander.

UNMANNED AIRCRAFT SYSTEM OPERATOR (15W)

1-41. The UAS vehicle operator (VO) (MOS 15W) is the final authority on the safe operation and security of the UA. The UAS operator (VO and mission payload operator [MPO] must be tactically, as well as technically, proficient in the unit mission essential task list (METL). The UAS operator is responsible for performance planning, remote operating of the UA, operating the mission sensor(s), performing initial data exploitation, and handling recovery of the UA. The operator additional skill identifiers (ASIs) are D7 for the RQ-7 Shadow and E7 for the RQ-5/MQ-5 Hunter.

EXTERNAL PILOT (RQ-5/MQ-5 HUNTER ONLY)

1-42. In coordination with the VO, the external pilot (EP) is responsible for the launch and recovery of the aircraft. The EP maintains and emplaces/displaces flight control box equipment, and is responsible for completion of the foreign object damage walk, runway functionality to include setup of runway lighting and assessment of arresting gear placement. The EP reports to the MC through the VO.

UNMANNED AERIAL SYSTEM OPERATOR (RQ-11 RAVEN)

1-43. The Raven UAS VO (MOS NONDESCRIPT) must be tactically, as well as technically proficient. The UAS operator is responsible for mission programming into the GCU, remote operating of the UA, and handling recovery of the UA. The battalion operations staff officer (S3)/intelligence staff officer (S2), not the UAS VO, completes mission determination and planning.

Chapter 2

Army Unmanned Aircraft Systems

UAS units are located throughout the Army from corps to platoon. UAS present the commander and staff with a new system that has potential for utilization in almost any mission profile. The lessons learned through UAS missions will establish the future use of these systems in the Army.

RQ-1L I-GNAT

CAPABILITIES

- 2-1. The following are some capabilities of the system:
- EO/IR sensor.
 - SAR/GMTI.
 - Versatile payload platform.
 - Multiple mission configurations.

UTILIZATION

- 2-2. Originally designed to perform tactical surveillance at altitudes up to 25,000 feet, the I-Gnat (figure 2-1) now has a turbocharged engine to increase its operating altitude to 30,500 feet with an endurance of up to 48 hours.



Figure 2-1. I-Gnat UA

SPECIFICATIONS

2-3. Data provided by several sources show slight variations, therefore direct system related questions to the Project Manager, UAS, at Redstone Arsenal, Alabama.

2-4. See table 2-1 for I-Gnat data.

Table 2-1. I-Gnat data specifications

<i>Design Feature</i>	<i>Specification</i>
Wing Span	42 ft (feet) 2.4 in (inch) (12.87 m [meters])
Weight	1,550 lb (pounds) (703.1 kg ([kilograms]))
Range	2,780 km
Airspeed	160 kt (knot) max
Ceiling	30,000 ft (9,144 m)
Endurance	48 hours
Launch/Recovery	2000 ft (609.6 m) Improved runway

SENSOR PAYLOADS

2-5. Skyball model MX-15 is a multi-sensor, gyro-stabilized platform with 360-degree field of view. Skyball is slewable in elevation and azimuth. The Skyball utilizes the following sensors.

- Daylight video camera (day TV), which includes spotter lens and zoom lens.
- IR lens system imagery, with four fields of view available.

2-6. The I-Gnat has a secondary sensor, the multi-mission optronic stabilized payload (MOSP) 280, same as used on the RQ-5/MQ-5 Hunter.

2-7. For specific questions on I-Gnat sensor payloads, contact the UAS project manager at Redstone Arsenal, Alabama. See table 2-2 for I-Gnat sensor characteristics.

Table 2-2. I-Gnat sensor characteristics

<i>Sensor Type</i>	<i>Detection</i>	<i>Recognition</i>	<i>Target Size</i>	<i>Sensor Altitude</i>
EO 770 MOSP	7.5 km detection field of view (FOV)	18 km narrow field of view (NFOV)	Target used is approximately 3.5 X 3.5 m	Performed at 8,000-10,000 ft (2,438 – 3,048 m) *AGL. Payload can perform at the higher platform altitudes as long as it is within the sensor's "slant range" capability.
Wescam MX15	Detect/recognize ranges have not been measured by the government.			
IR	9.0 km medium field of view (MFOV)	11 km NFOV	Same as above	
SAR-Lynx I	Strip mode has 3 m and 1 m ground resolution. Spot mode has 3 m/1 m/.3 m/.1 m ground resolution. Range varies depending on length of synthetic aperture. Nominal ranges are 7 to 40 km.			
* Above ground level				

GROUND CONTROL STATION

2-8. I-Gnat has the same level of control as the RQ-5 Hunter.

RQ-5/MQ-5 HUNTER

CAPABILITIES

2-9. Capabilities of the Hunter system include (>125 kilometers/12 to 16 hours):

- Multiple payload capability.
- Modular design enables growth.
- Extended range/endurance UAS.
- EO/IR sensor.
- Airborne data relay.
- Selection of single mission UAS or dual relay and mission UAS.
- Autonomous return upon data link loss.

UTILIZATION

2-10. Hunters (figure 2-2) have a demonstrated ability to fly in excess of 600 flight hours in a 30-day period, providing imagery and NRT data for ISR missions. Hunters can operate in relay with two UA airborne simultaneously for each mission, allowing for a range of 200 kilometers. An extended center wing (ECW) Hunter provides longer endurance and slightly higher (up to 16,000 feet [487.68 meters]) altitude tactical missions.



Figure 2-2. Hunter UA

SPECIFICATIONS

2-11. See table 2-3 for RQ-5A and ECW data.

Table 2-3. RQ-5A data specifications

<i>Design Feature</i>	<i>RQ-5A</i>	<i>ECW</i>
Wing Span	29 ft (8.84 m)	33 ft (10.06 m)
Weight	1,600 lb (725.75 kg)	1,800 lb (816.47 kg)
Range	125 km radius (line of sight [LOS] data link)	
Airspeed	70 kt loiter, 70 kt cruise, 100+ kt dash	
Altitude	15,000 ft (4,572 m)	16,000 ft (4,876.8 m)
Endurance	8-9 hours	10-16 hours
Payload(s)	EO/IR, airborne data relay and attack	
Launch/Recovery	Unimproved runway (paved or dirt). Runway length depends on air density and location surface. Up to a 1,600 ft runway may be required for takeoff. The minimum distance for a landing area is 600 ft (182.88 m).	

Electro-Optical/Infrared Payload

2-12. The MOSP (figure 2-3) is an airborne mission payload system installed in the UA and controlled remotely from the GCS. Commands sent for the MOSP system from the GCS via uplink transmission go to the UA digital central processing assembly (DCPA). The DCPA processes the commands and sends them to the payload control and logic box, which controls the stabilized platform assembly movement by servo loops. Live recording of MOSP video in the GCS is through the video cassette recorder (VCR). Recording still pictures from the video onto a VCR tape is also possible.



Figure 2-3. Hunter multi-mission optronic stabilized payload

2-13. See table 2-4 for the available MOSP configurations for the Hunter.

Table 2-4. Multi-mission optronic stabilized payload configurations

Sensor Type	TV Focal Length	IR Type	Auto Tracker
Day/Night	10 - 140 mm (millimeter)	1st generation	No
Day/Night	10 - 140 mm	1st generation	Yes
Day/Night	20 - 280 mm	1st generation	No
Day/Night	20 - 280 mm	1st generation	Yes
Day/Night	20 - 280 mm + extender to 770 mm	3d generation	Yes
Day/*LDRF (optional)	20 - 280 mm + 360 mm	N/A	Yes
Night/LDRF (optional)	N/A	3d generation	Yes

* Laser desinator and rangefinder

2-14. See table 2-5 for Hunter sensor characteristics.

Table 2-5. Hunter sensor characteristics

Sensor Type	Detection	Recognition	Target Size	Sensor Altitude
EO 140-mm	18 km	9 km	Target used is approximately 3.3 X 6.6 m	8,000 ft (2438.4 m) AGL
EO 280-mm	24 km	13 km		
EO 770-mm	30 km	17 km		
IR 1st generation	26 km	6 km		
IR 3d generation	32 km	12 km		

Remote Video Terminal

2-15. Each GCS/mission planning station (MPS) supplies two video data links to a RVT (figure 2-4) through a fiber optics cable. The data link range from the UA to the RVT is 40 kilometers. The fiber optics communication system/data link interface unit in the L/R station provides interface for the RVT. Transmission of EO video data, telemetry data, and status reports is from the MOSP system through the UA downlink to either GCS or to the RVT system.

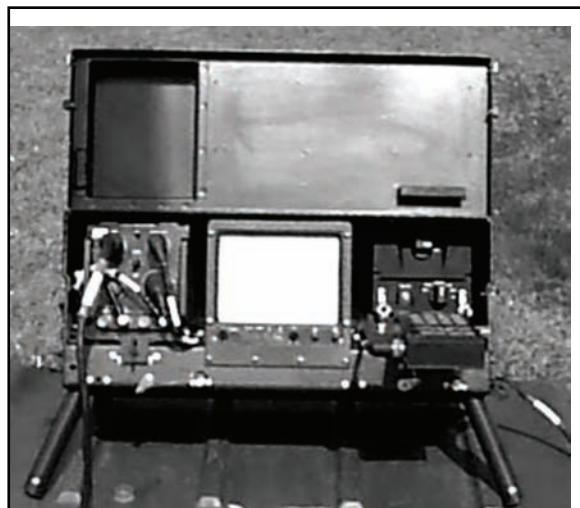

Figure 2-4. Hunter RVT

GROUND CONTROL STATION

2-16. Control of Hunter UA while in flight comes from one of two GCSs or the launch and recovery station (LRS). The GCS collects, processes, analyzes, and distributes digitized battlefield information by interfacing with currently fielded systems. Once the UA is airborne at approximately 3,500 feet (1,066.8 meters) and moving toward the objective area, the LRS passes control of the UA to a forward GCS to carry out the mission.

2-17. As a rule, two stations remain at the launch site, allowing one station to displace to an alternate location if needed during mission execution. This enables one station to recover the UA while the other is on the move. The forward control station is normally collocated with the supported unit.

2-18. Although GCSs control the UA, the RVT is another method of sharing the video feed provided by the UA. RVTs may be collocated with command posts (CPs) that do not have a GCS. Each RVT comes with a communications package allowing it to receive real-time video feed from selected UA and display the picture to observers on a small video screen.

2-19. The location of the RVT within the TOC is an issue of importance to ensure maximum utilization of system capabilities. When collocated with an All-Source Analysis System (ASAS) RWS, the RVT allows the military intelligence (MI) analyst at the RWS terminal to capture an image identified by the UAS operator on his screen, conduct a screen print, and carry out further detailed analysis of the image. When located next to the Advanced Field Artillery Tactical Data System (AFATDS), the RVT supports the fire and effects cell (FEC) and his crew using UAS data to execute calls for fire. Locating the RVT next to the Joint Surveillance Target Attack Radar System (JSTARS) common ground station (CGS) and air and missile defense workstation can also benefit operations, as these assets often work collectively against identified targets.

2-20. In digital tactical operations centers (TOCs), commanders and staff can view the UA picture on a screen of the command information center (CIC) in the briefing area without regard to the positioning of the RVT in the TOC.

RQ-7 SHADOW

CAPABILITIES

2-21. Capabilities of the Shadow system include—

- Multiple payload capability.
- Modular design enables growth.
- Early entry capability for 72 hours on one C-130 (minimum equipment for operation).
- One complete Shadow unit is transportable on three C-130s.
- Compatible with Army Battle Command System (ABCS).
- EO/IR sensor.

UTILIZATION

2-22. RQ-7's (figure 2-5) tasks include day/night reconnaissance, surveillance, TA, and BDA. The RQ-7 can be equipped with a global positioning system (GPS)-based navigation system for fully autonomous operations. The primary mission payload is the plug-in optronic payload (POP) EO/IR sensor. The Shadow's EO/IR payload is capable of producing color video during daylight operations and black and white thermal images at night. This system can spot ambush sites or insurgents planting improvised explosive devices (IEDs). Other payloads under consideration include the SAR/moving target indicator (MTI) and one with a laser rangefinder/designator (LRF/D).



Figure 2-5. Shadow UA

2-23. The RQ-7B (figure 2-6) has larger wings with a more efficient airfoil and increased fuel capacity, allowing an endurance of 5 hours. Additionally, the vehicle has an enlarged tail, upgraded avionics (including an improved flight controller with an inertial measurement unit and increased computing power), and new payload options. The RQ-7B is also fitted with the Army's tactical common data link (TCDL).



Figure 2-6. Shadow RQ-7B UA

SPECIFICATIONS

2-24. See table 2-6 for RQ-7A and RQ-7B data.

Table 2-6. RQ-7A and RQ-7B data specifications

Feature Design	RQ-7A	RQ-7B
Wing Span	13 ft (3.97 m)	14 ft (4.27 m)
Weight	350 lb (158.76 kg)	380 lb (172..37 kg)
Range	125 km. The UA is further limited to 50 km (LOS data link) with a single GCS.	
Airspeed	70 kt loiter, 70 kt cruise, 105 kt dash.	60 kt loiter, 70 kt cruise, 105 kt dash
Altitude	15,000 ft (4,572 km) mean sea level (MSL)	
Endurance	5 hours	
Payload(s)	EO/IR sensors	
TCDL	No	Yes
Laser Designation	No	Yes in 2006
Launch/Recovery	100 m x 50 m area	

Electro-Optical/Infrared Payload

2-25. The EO/IR payload (figure 2-7) is a multi-mode, forward looking infrared (FLIR)/line scanner/TV sensor with resolution sufficient to detect and recognize an armored personnel carrier sized target from operational altitudes (for example, >8,000 feet AGL [day] and >6,000 feet AGL [night]) and at survivable standoff range (3 to 5 kilometers) from imaged target. Imagery are preprocessed onboard the UA and passed to the GCS via the system data link. The payload is capable of autonomous preplanned operation and instantaneous retasking throughout a mission. The EO/IR payload provides continuous zoom capabilities when in EO mode and multiple FOVs when in IR, selectable by the MPO.

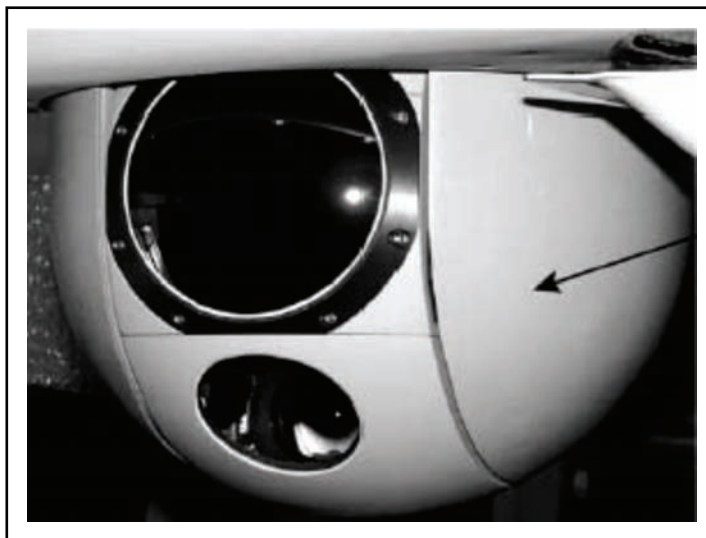

Figure 2-7. Shadow mission payload

2-26. See table 2-7 for Shadow sensor characteristics.

Table 2-7. Shadow sensor characteristics

Sensor Type	Detection	Recognition	Target Size	Sensor Altitude
POP200 EO	4.8 km (7-degree FOV)	4.8 km (1.76-degree FOV)	Target used is approximately 3.5 X 3.5 m	8,000 ft AGL
POP200 IR	4.7 km MFOV	4.7 km NFOV		6,000 ft AGL
POP200 EO	8.4 km (4-degree FOV)	8.4 km (1 degree FOV)		8,000 ft AGL
POP200 IR	7.1 km MFOV	7.1 km NFOV		6,000 ft AGL

Remote Video Terminal

2-27. The RVT (figure 2-8) is a portable system that receives, processes, and displays NRT video images and telemetry from the UA. The RVT receives video and telemetry signals from the UA through either the antenna or GCS. The RVT receives direct downlink from the UA when within 50 kilometers of the UA and displays annotated imagery to the operator (same as MPO display in the GCS). In addition, the RVT can store imagery, recall selected segments, and display NRT imagery with annotation, to include date/time group and selectable target location (in latitude/longitude, military grid reference system, and universal transverse mercator coordinates) when in the center FOV, north seeking arrow, UA position, and heading.

2-28. The system has four RVTs to provide payload information to support units. The commander, based on mission, enemy, terrain and weather, troops and support available, time available, and civil considerations (METT-TC), allocates RVTs to support his scheme of maneuver. The RVT is user friendly and easy to operate. A supported unit Soldier transports and operates the RVT. Supported units receive the RVT and operator training from the Shadow platoon.

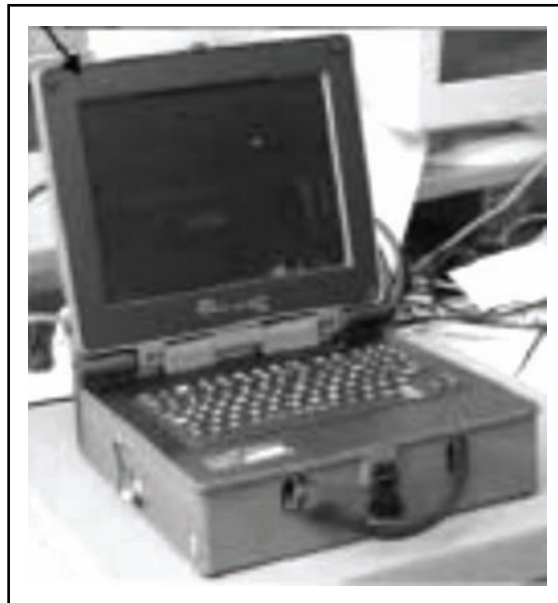

Figure 2-8. Shadow RVT

GROUND CONTROL STATION

2-29. The GCS has two primary functions. First, it is the primary means used to control, track, and operate the UA. Second, it is used to manipulate the payload, receive, and process telemetry and video downlinks. The GCS also incorporates mission-planning functions with the ability to call for and adjust indirect fire.

2-30. The GCS has two operator positions, a VO position and MPO position. It contains the following consoles:

- The left console is normally the VO position.
- The right console is normally the MPO position.

2-31. Both operator positions are identical in capabilities, therefore a transfer of functions can occur between consoles in the event of an operator position failure.

2-32. A GCS can only communicate with and control one UA at a time. The GCS can also place a mission UA in programmed flight and be free to acquire another UA during a handover from another GCS or to the L/R site.

2-33. The GCS controls the UA by data link through the GDT, up to a distance of 50 kilometers (31 miles), as long as LOS is maintained between the GDT and the UA. The GCS does not have the ability to operate while on the move.

RQ-11 RAVEN

CAPABILITIES

2-34. Capabilities of the Raven system include—

- Hand launched/auto land or manual recovery.
- Auto navigation using military Py Code GPS.
- Manual navigation and flight modes.
- UA quick assembly (< 3 minutes).
- Man/backpack portable.
- Reusable (100+ flights).
- Climb to operational altitude in 1 to 2 minutes.

UTILIZATION

2-35. The Raven is a man-portable, hand-launched small unmanned aerial vehicle (SUAS) system designed for R&S and remote monitoring. The operator can launch and recover an UA in minutes from unprepared terrain without special equipment. It can be either remotely controlled from the GCU or fly completely autonomous missions using GPS waypoint navigation. The UA will immediately return to its launch point by selecting the “home” command.

2-36. Most Raven UA (figure 2-9) missions occur at 100 to 300 feet (30.5 to 91.4 meters). Flight of the UA is conducted through active control inputs or set waypoints. Design features include the use of the military standard Py Code GPS and a rechargeable battery option. Disposable batteries are available but do not provide a significant increase in performance over rechargeable batteries and are not fielded with the system. The majority of missions use a lithium-ion (Li-Ion) battery pack rechargeable through a variety of sources, including the 28-volt direct current outlet on a Humvee. Depending on the battery used, mission time can range from 60 to 90 minutes. The Raven system also includes a Panasonic Toughbook computer used in conjunction with the GCU, as well as a Sony Handycam video camera. The computer uses

FalconView joint mapping software to provide the overlay of the video image on top of a five-color map display. The video camera allows the recording of Raven imagery for additional analysis or exploitation.



Figure 2-9. Raven UA

SPECIFICATIONS

2-37. See table 2-8 for Raven data.

Table 2-8. Raven data specifications

<i>Feature Design</i>		<i>Specification</i>
Power		Li-Ion rechargeable battery
Wing Span		4.5 ft (1.37 m)
Weight		
	UA	4 lb (1.81 kg) (12 lb [5.44 kg] with carrying case)
	GCU	17 lb (7.71 kg)
Range		8-12 km
Airspeed		23 kt loiter, 34 kt cruise, 60 kt dash
Altitude		150-1,000 ft (45.72-304.8 m) AGL
Endurance		60 to 90 minutes (Li-Ion – rechargeable)
Payload(s)		EO/IR sensors
Launch/Recovery		Hand-launched/auto land recovery on soft, unimproved surface
Crew		Two MOS nonspecific Soldiers

ELECTRO-OPTICAL OR INFRARED PAYLOAD

2-38. The optics package includes an EO, color camera nose (side and forward look) for day operations, and two IR/thermal noses (one side and one forward look) for night operations. See table 2-9 for Raven sensor characteristics.

Table 2-9. Raven sensor characteristics

<i>Feature Design</i>	<i>EO</i>	<i>IR</i>
Pixels	768H X 494V	160H X 120V
Payload Nose Weight	6.2 oz	6.5 oz

2-39. The Raven UA carries either an EO or an IR camera in a detachable nose. Three payload noses are included with the system (figure 2-10): one EO nose holds cameras in forward and side-look positions, one IR nose holds a camera in the forward look position, and one IR nose holds a camera in the left side look position.

2-40. Video clarity begins to degrade above 500 feet (152.4 meters) AGL.

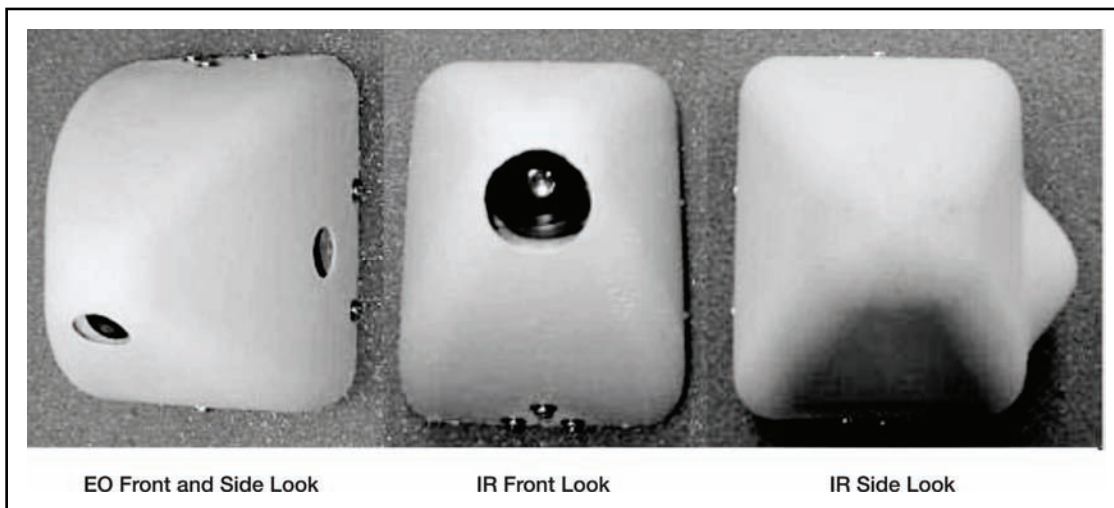
**Figure 2-10. Camera payloads**

REMOTE VIDEO TERMINAL

2-41. The UAS transmits live airborne video images and compass headings (location information) from the UA to a GCU and RVT, enabling operators to navigate, search for targets, recognize terrain, and record all information for (later) analysis.

2-42. The RVT (figure 2-11) display is a receive-only monitor with no aircraft control functions. Use the RVT to view real-time video from any location within 5 to 10 kilometers LOS of the aircraft. A single BA-5590 or BB-390 battery powers the RVT.

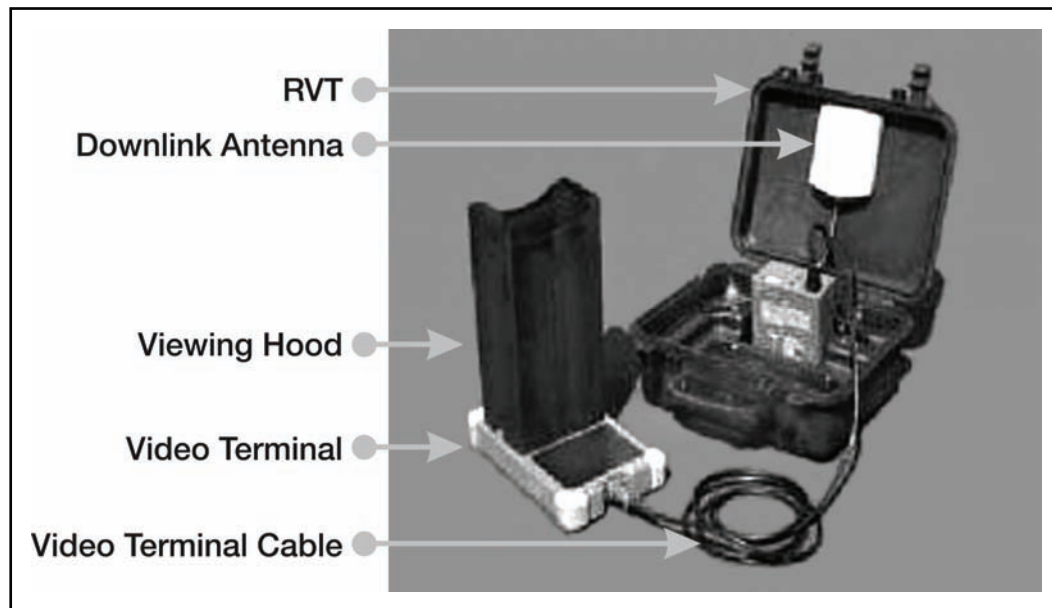

Figure 2-11. Raven RVT

GROUND CONTROL UNIT

2-43. The Raven GCU is typically located at the highest available elevated position, away from the TOC, to obtain the clearest LOS for conducting operations. The Raven RVT is located in the TOC/CP. This arrangement facilitates Level II interoperability. The payload is hard-mounted to the UA and does not require a separate payload operator from the UA operator. Exercise of Level IV interoperability is possible, but is not a normal Raven level of interoperability.

2-44. Operation of the GCU usually occurs at a fixed site, allowing for an unobstructed LOS. However, the GCU can continue to operate the UA while inside a moving vehicle. The primary concern when operating from a moving vehicle is selecting a route that provides a continuous LOS with the UA. Because of the 10 kilometers LOS range of the RVT and GCU, the leadership should plan for and train Raven operators on handover operations. The leadership should be familiar with the handover procedure to know how best to prepare, and when the most opportune time and place is to perform the procedure.

This page intentionally left blank.

Chapter 3

Joint Unmanned Aircraft Systems

At the joint level, numerous other UAS exist. Army units may receive support from one or more of these assets so it is important that commanders and their staffs understand the capabilities of each system.

SECTION I—JOINT UAS REQUEST PROCEDURES

3-1. Dissemination of UAS-collected ISR products occur through established communications between the UAS ground stations and exploitation systems. The joint UAS provide battlefield imagery and other intelligence products to national and theater intelligence centers, theater exploitation systems, joint force commanders (JFCs), and warfighting forces equipped with compatible imagery terminals. Most joint UAS can operate from forward-deployed locations or reside with theater exploitation systems at an established base of operations. The supported command is responsible for integrating deployed UAS communications systems into the theater defense information infrastructure to provide timely dissemination of collected intelligence to the requesting customer.

3-2. The intelligence directorate of a joint staff—intelligence staff section (J2)—reviews, validates, and prioritizes collection requirements for joint UAS operations. The operations directorate of a joint staff—operations staff section (J3)—in coordination with the J2, forwards these requirements to the commander exercising TACON over theater R&S assets. The component commander then tasks the asset to satisfy the JFC requirement. Normally, the joint force air component commander (JFACC) in the ATO, in accordance with JFC priorities, tasks airborne reconnaissance and surveillance assets.

JOINT COMMAND ARCHITECTURE

JOINT FORCE COMMANDER'S GUIDANCE

3-3. JFC guidance provides unity of effort between subordinate component commanders. Like all theater reconnaissance assets, joint forces task joint UAS to support the overall JFC strategy and guidance. The JFC can be a theater, subunified commander, or joint task force (JTF) commander.

JOINT FORCE AIR COMPONENT COMMANDER RESPONSIBILITIES

3-4. The JFC is principally responsible for airspace control in the operational area. The JFC expresses airspace use through the airspace control plan and ACO to support mission accomplishment. The JFC normally designates a JFACC and assigns responsibilities that include, but are not limited to, planning, coordinating, and monitoring joint air operations, as well as the allocation and tasking of joint air operations forces based on the JFC's concept of operations and air apportionment decision. When the JFC designates a JFACC, the JFACC normally assumes area air defense commander (AADC) and airspace control authority (ACA) responsibilities because AD and airspace control are an integral part of joint air operations. The ACA develops policies and procedures for airspace control and coordination required among units within the operational area.

JOINT AIR OPERATIONS CENTER

3-5. The effective and efficient use of joint UAS requires coordination and consultation between the Joint Air Operations Center (JAOC) and multi-service/coalition liaisons within the JAOC. This coordination is essential to ensure joint UAS are used where and when they add most to synchronized battlefield operations. Additionally, the JFC campaign plan determines the UAS role (reconnaissance/surveillance/targeting) and is a point of emphasis in UAS operations planning and execution. As a result, the primary force management planner shifts between the J2 and the J3 with the JFACC as the focal point for integrating/synchronizing UAS capabilities to provide a maximum air effort for the JFC's campaign plan. Personnel plan joint combat operations in accordance with theater-specific operational procedures.

AIR TASKING ORDER PROCESS

3-6. The means for implementing joint UAS mission support is the ATO. The ATO includes the UAS employment plan. The JFACC tasks the UAS sorties through the ATO to accomplish specific missions, provide sufficient data, and detail enabling joint forces to execute other reconnaissance, surveillance, and target acquisition (RSTA) missions. The support element must be capable of generating the mission plan within the time constraints of the ATO cycle. The JAOC issues a valid ATO for a specified period. The JAOC's combat plans division determines the UA orbit location based on prioritized coverage requirements, communications connectivity with supported units, and survivability considerations. While the ATO itself covers a specific period, the ATO planning, coordination, and execution process is continuous. Because of the endurance characteristic (>24 hours) of some joint UAS, a single joint UAS mission may cross several ATO cycles.

LIAISON

3-7. Other service UAS liaison officers (LNOs) may be available to the JAOC. If present, the LNO responsibilities include—

- Advising the supported commanders of the system's roles, capabilities, and limitations.
- Monitoring mission execution to ensure tasking support.
- Assisting in dissemination of UAS derived data.
- Planning UAS missions.

UNMANNED AIRCRAFT SYSTEM SUPPORT

3-8. If joint UAS support is required, the requesting Army commander provides required coverage area, effective employment times, and sensor priorities to the next higher commander using the air support request (AIRSUPREQ) message format. The request is forwarded through the chain of command to the Army forces (ARFOR) Assistant Chief of Staff-Intelligence (G2). If the ARFOR G2 determines that no Army system can obtain this information, the ARFOR G2 forwards the request to the JFC J2 for prioritization. The J2 has authority to task a platform other than the one requested. Using the allocation and apportionment process, a request for information, not for a specific system, is the standard. Units transmit AIRSUPREQs to the JAOC no later than 24 hours before the air-tasking day (0600L) or earlier as directed by the theater operation plan or JFC. The JFACC determines the number of UA needed to provide the requested coverage and considers this in his daily submission of the apportionment recommendation. The JFC, through his daily apportionment decision, determines which commanders will receive UAS support. At this level, UAS operations are coordinated with other collection platforms in theater such as JSTARS, U-2, or similar platforms. During mission execution, the supported unit may request changes in the coverage area, times, or radar priorities by coordinating through the appropriate C2 authorities.

AIR SUPPORT REQUEST

3-9. Personnel submit requests for direct support of a preplanned mission using DD Form 1972 (Joint Tactical Air Strike Request), DD Form 1975 (Joint Tactical Air Reconnaissance/Surveillance Request), or the air support request process. Requests for support of an immediate mission are submitted directly to the theater air operations center. See FM 101-5-2 for these message formats, or Adobe (PDF) format forms can be downloaded from <http://www.dtic.mil/whs/directives/infomgt/forms/formsprogram.htm>.

ROUTINE TASKING

3-10. Units accomplish the task of imagery collection through the established JTF collection management process via the ATO. Tasking comes in two formats: the ATO and execution cell ad hocs. The ATO, developed by the combat plans division of the JAOC, details the products required. It takes into account the limited exploitation capability of the GCS and the expanded production capability of the major intelligence production centers. It also accommodates the unique capabilities of each UAS. The ATO specifies types of products needed to fill user requests and when those products are required. It also directs the number and frequency of visits and reconnaissance, surveillance, and stare options based on the UAS capability. Requested target types are also detailed and important to mission planning and exploitation process. These types include point and area targets as well as line of communications (LOC). The ATO may direct sensor use that can most appropriately capture the desired intelligence.

AD HOC TASKING

3-11. The execution cell in the combat operations division of the JAOC develops an ad hoc tasking. Execution cell direction is supplemental to the ATO and used to modify UAS tasking to support changing mission objectives. This tasking may include time-sensitive changes to the ATO regarding UAS tasking or may require an entirely new UAS mission. It contains the same type of information included in the ATO. Because of the flexibility of UAS and their long mission duration, the UA can be airborne in excess of an entire ATO cycle. The GCS will likely receive some ad hoc tasking while the UA is in flight. Normally assigned at the JFACC level, UAS LNOs provide information to requesters as well as evaluate and filter ad hoc requests. Personnel accomplish these actions with JTF coordination and approval.

MISSION CHANGES/DYNAMIC RETASKING

3-12. During mission execution, commanders or units supported by joint UAS may request changes in coverage area and times. Changes requiring modification of the established orbit must be coordinated with appropriate air space management and AD elements. The Theater Air Ground System (TAGS) serves as the framework to ensure proper command and coordination lines between joint customers of UAS.

TARGET LISTS AND TARGET DECKS

3-13. The collection manager has access to the "target deck," which lists all the intelligence target requests and target data. Through effective use of the target deck, the collection manager tracks the servicing of targets, results of the service, determines whether further or continuing action is required, and maintains the target deck information as encyclopedic data. Each flight updates data on each target by viewing that specific target or area.

3-14. As the collection manager assigns collection requirements to the selected UAS, the intelligence LNO (at the tasking agency) notifies the UAS unit to commence planning the mission. In addition, the UAS air LNO (at the airspace coordination agency) commences airspace planning. Because initial planning of missions occurs up to 4 days prior to execution, several missions are in various planning stages at any given time. Coordination of the executed mission takes precedence, but personnel must also consider coordination requirements in the planning stages. From the receipt of tasking through the conclusion of the

mission, units conduct mission planning and airspace coordination concurrently with frequent interface between the intelligence and air LNOs.

TROJAN SPIRIT II

3-15. Trojan Spirit (TS) II is an Army satellite communications (SATCOM) terminal and system that provides access to intelligence dissemination and processing systems. Equipment consists of two HMMWVs with shelters, two trailer-mounted SATCOM antennas, and two diesel-powered generators. Two types of GDTs are used: a 5.5-meter dish and a 2.4-meter dish. Personnel use the larger dish for imagery relay from and a command link to the UA, whereas the smaller dish is used for passing selected imagery from the GCS into the Joint Deployable Intelligence Support System (JDISS). TS II provides Joint Worldwide Intelligence Communications System, secret internet protocol router network (SIPRNET), or point-to-point dedicated connectivity, and utilizes JDISS to disseminate imagery and data to national and theater intelligence servers. The ASAS LAN hosting JDISS software completes the information architecture.

SECTION II—AIR FORCE

RQ-4 GLOBAL HAWK

3-16. The Global Hawk (figure 3-1) is the United States Air Force's (USAF's) first operational UAS in the high altitude, long endurance category. In January 1997, the Global Hawk UAS was designated RQ-4A.



Figure 3-1. Global Hawk

3-17. A Rolls-Royce/Allison F137-AD-100 (model AE 3007H) turbofan powers the RQ-4A. It takes off and lands on conventional runways using a retractable tricycle landing gear. The prominent nose bulge houses the wideband SATCOM antenna that is 1.2 meters (4 feet) in diameter. The vehicle can reach an altitude of 19,800 meters (65,000 feet) and can remain airborne at least 36 (with a maximum endurance of up to 42) hours.

3-18. A Global Hawk system consists of two RQ-4A UA and two major ground stations that include the RD-2A mission control element (MCE) and the RD-2B launch and recovery element (LRE). The LRE is the location where autonomous flight data is loaded into the UA's GPS/inertial navigation system (INS), the UA is controlled during takeoff and landing, and the UA's flight performance is monitored. MCE personnel control and monitor the sensor systems. Both the LRE and MCE can control three RQ-4As simultaneously. The main components of the RQ-4A's integrated sensor suite for its surveillance, reconnaissance, and TA missions include SAR/MTI and EO/IR sensors. For self-defense, the UA is equipped with an AN/ALR-69 radar-warning receiver and AN/ALE-50 towed decoys.

3-19. In April 2003, an enlarged derivative of the RQ-4A was designated RQ-4B. The RQ-4B has a 50 percent higher payload capability than the RQ-4A and carries additional signal intelligence (SIGINT) and electronic intelligence payloads.

UTILIZATION

3-20. Global Hawk is optimal for supporting low-to-moderate threat, long endurance surveillance missions in which range, endurance, and time on station are paramount. Global Hawk provides USAF and joint battlefield commanders NRT high-resolution ISR imagery. In one year, Global Hawk provided Air Force and joint warfighting commanders more than 15,000 images to support Operation Enduring Freedom (OEF), flying more than 50 missions and 1,000 combat hours to date. Cruising at extremely high altitudes, its cloud penetrating SAR/MTI sensors can image an area the size of Illinois (40,000 nautical square miles) in just 24 hours. Imagery is relayed through satellite and ground systems in NRT to battlefield commanders, thereby providing the most current information about enemy location, resources, and personnel.

3-21. The MCE processes Global Hawk EO/IR and SAR imagery prior to display and (or) dissemination. Expect total processing time within the MCE prior to dissemination to be less than 30 seconds. Dissemination of primary imagery is in national imagery transmission format standard 2.0 format and encrypted for transmission. All received imagery will also be routed within the MCE to a redundant array of inexpensive discs storage device. The device can store image data for up to 24 hours and is designed as a backup should disseminated imagery not be received by the destination owing to technical and communications failure. This storage capability will not be available as an archive for user access. Preselected images will automatically pass to the JDISS processor for selected dissemination.

3-22. All Global Hawk data links are secure and have a voice channel for communications through a very high frequency (VHF)/ultra high frequency (UHF) voice relay. While this voice link is primarily for airspace coordination, it allows Global Hawk operators to talk through the UA relay to anyone within LOS of the UA, allowing use as a tactical circuit with JSTARS, Airborne Battlefield Command and Control Center, Airborne Warning and Control System (AWACS), and others. The MCE incorporates an ARC-210 for direct LOS VHF/UHF voice communications with airspace control authorities.

SPECIFICATIONS

3-23. See table 3-1 for RQ-4A and RQ-4B data.

Table 3-1. RQ-4A/RQ-4B data specifications

<i>Feature Design</i>	<i>RQ-4A</i>	<i>RQ-4B</i>
Length	13.53 m (44 ft 4.75 in)	14.50 m (47 ft 7 in)
Wingspan	35.42 m (116 ft 2.5 in)	39.90 m (130 ft 11 in)
Height	4.64 m (15 ft 2.5 in)	
Weight	Max: 11,600 kg (25,600 lb) Empty: 6,710 kg (14,800 lb)	
Speed	648 km/h (403 mph)	
Ceiling	19,800 m (65,000 ft)	
Range	21,720 km (11,730 nm [nautical mile])	
Endurance	36 hours	
Propulsion	Rolls-Royce/Allison F137-AD-100 turbofan	

RQ/MQ-1 PREDATOR

3-24. The Predator is the USAF's first operational tactical multi-mission UAS. DOD introduced a new Q-for-UAS category in its designation system for manned aircraft. The Predator was designated RQ-1. The designation RQ-1A refers to a whole UAS (including ground equipment), whereas the UA are designated RQ-1K. Mentioned below are other components of the Predator system that have designations in the RQ-1 series.

3-25. The Predator GCS controls one Predator without the ability to relieve a vehicle on station. All mission imagery recording is located in the GCS because the Predator has no onboard recording capability. The payload operator workstations are the primary means for providing direct and responsive primary control of the UA and sensor payload. The data exploitation, mission planning, communication workstations allow data exploitation, mission planning, mission and payload monitoring, and system management. SAR workstations control, monitor, and are accessible for limited exploitation of the SAR data. External communications are via high frequency (HF)/UHF/VHF (voice/data), cellular/landline telephones, and hardwire connectivity with the TS II SATCOM terminal. Use of other SATCOM systems to link the GCS to intelligence architecture is possible.

3-26. The UAS GCS is a single 30-foot trailer, containing pilot and payload operator consoles, three Boeing Data Exploitation and Mission Planning Consoles and two SAR workstations together with satellite and LOS GDTs. The GCS can send imagery data via a landline to operational users or to the TS II data distribution system. The TS II data distribution system is equipped with a 5.5-meter dish for Ku-Band GDT and a 2.4-meter dish for data dissemination.

3-27. The RQ-1K is powered by a Rotax 912 UL piston engine driving a two-blade pusher propeller and features an inverted V-tail. With its retractable tricycle landing gear, the Predator takes off and lands like a conventional airplane. It has a fixed nose-mounted color TV camera for remote piloting and automatic navigation. It is equipped with a GPS-aided INS. Primary mission equipment of the RQ-1K is a Northrop Grumman AN/ZPQ-1 tactical endurance synthetic aperture radar (TESAR) surveillance radar and a Wescam Versatron 14TS EO/IR sensor turret.

3-28. Ground equipment of an RQ-1A system includes the RQ-1P GCS, which uses C- and Ku-Band data links for LOS and NLOS communication with the UA, respectively. Range of the NLOS link, and therefore the effective operational radius of the aircraft, is about 740 kilometers (400 nautical miles). An AN/TSQ-190(V) Trojan Spirit (TS) II is the NLOS communication SATCOM link and has a designation as RQ-1U within the Predator system nomenclature. TS II is an Army system used to communicate Predator data. If the data link is lost, the Predator UA returns to base as programmed.

3-29. The RQ-1L (figure 3-2) UA has a higher performance turbo-supercharged Rotax 914 UL engine and deicing equipment. It can reach altitudes of 7,920 meters (26,000 feet), where it can cruise for at least 20 (and possibly up to 24) hours at 110 to 130 kilometers per hour (60 to 70 knots). On later RQ-1Ls, the Raytheon AN/AAS-52(V) multi-spectral targeting system (MTS) EO/IR sensor turret, also housing a laser designator, replaced the Wescam 14TS. Ground equipment improvements include a secure air traffic control (ATC) voice relay, a second data link in the GCS to support simultaneous control of two UA, an Air Force mission support system workstation in the GCS, and general maintainability and reliability upgrades. The Block 1 GCS is designated as RQ-1Q, while the latest Predator satellite link is known as RQ-1W Predator primary satellite link (PPSL).

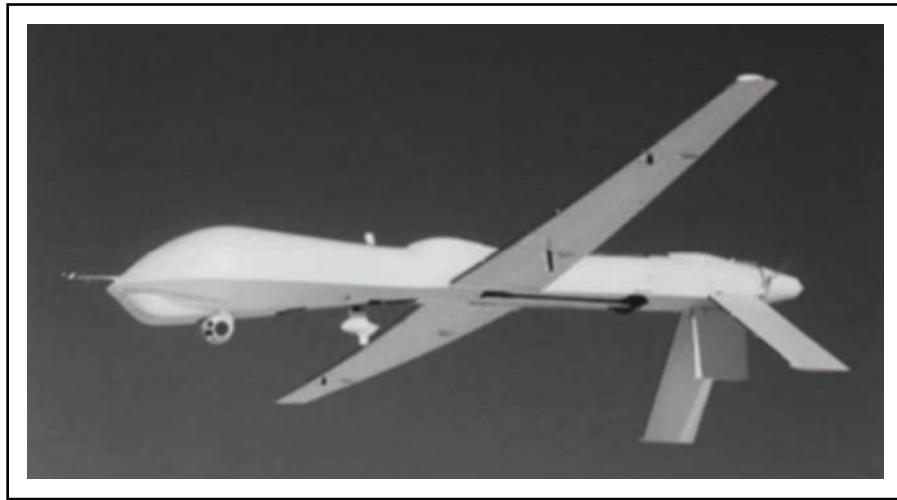

Figure 3-2. Predator RQ-1L

3-30. The Predator UA can carry and fire [AGM-114C Hellfire semi-active laser \(SAL\)](#)-guided anti-armor missile). Those RQ-1Ls, which are equipped to launch Hellfire, are redesignated MQ-1L (figure 3-3). The designation of the corresponding Predator system also changed to MQ-1B. Other missiles and guided weapons, including the [FIM-92 Stinger](#) air-to-air missile, are used on the MQ-1L as well.

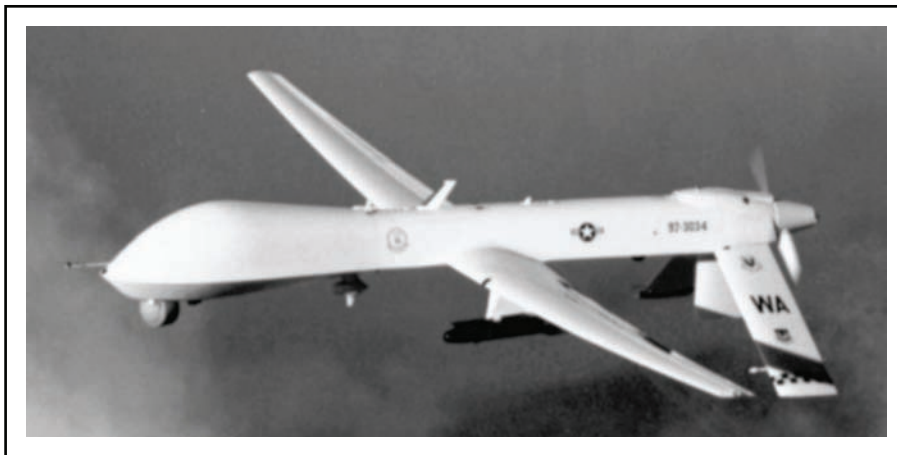

Figure 3-3. Predator MQ-1L

3-31. The USAF uses the designations RQ-1A/B for the whole Predator system, including ground equipment. The designations RQ-1K and RQ-1L apply to UA of the RQ-1A and RQ-1B systems, respectively. The Predator GCS is called RQ-1P, and the TS II SATCOM station is designated RQ-1U. The designation MQ-1B refers to the Predator system with modified UA that carry the AGM-114 Hellfire anti-armor missile. The armed UA are designated MQ-1L. RQ-1Q is an upgraded GCS, and RQ-1W is a new SATCOM station known as PPSL.

UTILIZATION

3-32. The RQ-1/MQ-1's primary mission is to interdict and conduct armed reconnaissance against critical, perishable targets. When the MQ-1 is not actively pursuing its primary mission, it augments the RQ-1 as a

JFACC)-owned theater asset for reconnaissance, surveillance, and TA in support of the JFC. The aircraft is equipped with a color nose camera (used by the UA operator for flight control), a day variable aperture television camera, a variable aperture IR camera (for low light/night), and a SAR for penetrating smoke, clouds, or haze. The cameras produce full motion video and the SAR still-frame radar images.

3-33. It is possible to forward image data (to include annotated freeze frames and voice-overs) to the TS II for dissemination by the JDISS. EO/IR full motion video is transmittable over analogue LOS and digital Ku Band links. SAR is transmittable over the Ku Band link only. Full motion video can be directly disseminated by the omni-directional broad beam LOS link (C-Band), via Ku Band TS II into the TS II net, or via very small aperture terminal into the Joint Broadcast System (JBS)/Global Broadcast System (GBS). SAR is a series of still images (no motion). SAR can be disseminated via the TS II Ku Band link to a theater collection cell, intelligence server (joint intelligence center [JIC]/joint analysis center [JAC]), or to a suitably equipped customer. Motion video can be disseminated directly by the TS II.

SPECIFICATIONS

3-34. See table 3-2 for RQ-1L data.

Table 3-2. RQ-1L data specifications

Feature Design	Specification
Length	8.13 m (26 ft 8 in)
Wingspan	14.83 m (48 ft 8 in)
Height	2.21 m (7 ft 3 in)
Weight	Max: 1,020 kg (2,250 lb) Empty: 430 kg (950 lb)
Speed	Max: 217 km/h (117 kt) Cruise: 110-130 km/h (60-70 kt)
Ceiling	7,920 m (26,000 ft)
Range	740 km (400 nm)
Endurance	> 20 hours
Propulsion	Rotax 914 UL piston engine; 78.3 kW (105 hp)

MQ-9 PREDATOR B

3-35. The Predator B (figure 3-4 and figure 3-5) is a larger and more powerful derivative of the [RQ/MQ-1](#). The major difference in layout is the upward V-tail. The basic equipment suite of the Predator B is similar to the RQ/MQ-1 Predator, and the primary mission equipment consists of a Raytheon AN/AAS-52(V) MTS EO/IR sensor turret/laser designator and a General Atomics AN/APY-8 Lynx SAR. The Predator B can carry and fire the [AGM-114C/K Hellfire](#) missile. The Predator B is compatible with the ground-based communications equipment of the MQ-1B Predator system, so it can supplement or replace the latter relatively seamlessly.



Figure 3-4. Predator B MQ-9A in flight



Figure 3-5. Predator B MQ-9A on the ground

UTILIZATION

3-36. Mission utilization of the MQ-9 is similar to the RQ-1/MQ-1.

SPECIFICATIONS

3-37. See table 3-3 for MQ-9A data.

Table 3-3. MQ-9A data specifications

<i>Feature Design</i>	<i>Specification</i>
Length	10.97 m (36 ft)
Wingspan	20.12 m (66 ft)
Height	3.56 m (11 ft 8 in)
Weight	Max: 4,540 kg (10,000 lb) Empty: 1,380 kg (3,050 lb)
Speed	> 405 km/h (220 kt)

Table 3-3. MQ-9A data specifications

<i>Feature Design</i>	<i>Specification</i>
Ceiling	13,700 m (45,000 ft)
Endurance	> 24 hours
Propulsion	Honeywell TPE-331-10T turboprop; 579 kw (776 hp)

FORCE PROTECTION AERIAL SURVEILLANCE SYSTEM–DESERT HAWK

3-38. The Force Protection Aerial Surveillance System is a product of the Lockheed Martin Aeronautics Company/Palmdale. It was nicknamed Desert Hawk by the general in charge of air forces in the Middle East. The Desert Hawk is just 32 inches long with a wingspan of 52 inches, powered by an electric motor and able to fly for 60 to 90 minutes at a time.

UTILIZATION

3-39. The Desert Hawk's main objective is to cover the surface-to-air missile (SAM) footprint. It actively searches for personnel employing a shoulder-fired missile (rocket propelled grenade, SA-7, SA-18, and others) against aircraft in the process of taking off, in the vicinity of, or landing at an airfield. If the UA operator detects any suspicious activity, a dispatched security patrol proceeds to the area of interest.

3-40. Desert Hawk's cameras chronicle every flight on a mini digital-tape recorder simultaneously, allowing the operator to watch real-time images on the laptop computer. The operator also has the option of taking computer snapshots.

3-41. The system has six Desert Hawk UA, a ground station, a remote viewing terminal, interchangeable payloads (color cameras and thermal imagers for day/night operations), and a field kit for repairs. Personnel enter programmed missions in advance using the touch-screen interface on the laptop computer. Coordinates are entered and plotted using GPS navigation, allowing the user to direct the UA even while the UA is in flight (figure 3-6).



Figure 3-6. Desert Hawk system

3-42. The aircraft lands by itself without guidance from its operator. The UA can operate from a clearing as small as 100-meter square. A bungee cord, which can stretch to 150 feet, launches the UA up 200 feet into the air (figure 3-7).



Figure 3-7. Launching Desert Hawk

3-43. The battery operated UA operates between 300 and 500 feet altitude, sending back real-time overhead video. The system is not rucksack portable, but transported by general-purpose vehicle. The aircraft is made of damage-resistant molded material and designed for limited field repair. Missions are preprogrammed, but in-flight changes are possible on the laptop computer screen.

SPECIFICATIONS

3-44. See table 3-4 for Desert Hawk data.

Table 3-4. Desert Hawk data specifications

<i>Feature Design</i>	<i>Specification</i>
Power	Rechargeable batteries
Wing Span	52 in
Length	32 in
Weight	7 lb
Range	10 km
Airspeed	50 kt max
Altitude	1,000 ft AGL
Endurance	60 - 90 minutes
Payload(s)	EO/IR sensors
Launch/Recovery	Hand launched with bungee cord/auto land recovery on soft, unimproved surface 100 X 100 m clearing
Crew	Two airmen

SECTION III—NAVY**RQ-2 PIONEER**

3-45. The United States Navy's (USN's) Pioneer (figure 3-8) was the first tactical battlefield UAS in service with the U.S. armed forces. The Navy deployed Pioneer systems from Iowa class battleships, whereas the United States Marine Corp (USMC) employed Pioneer units on land bases. The Pioneer UAS did not receive the official military designation of RQ-2A until the DOD introduced a new Q-for-UAS category in its aircraft designation system in January 1997.



Figure 3-8. Pioneer UA

3-46. The RQ-2A is of twin-boom pusher configuration and powered by a single Sachs and Fichtel SF2-350 two-cylinder two-stroke piston engine. When deployed on land bases, the UA either can take off conventionally on its nonretractable tricycle landing gear or launched by catapult or rocket booster. On USN ships, a MK 125 MOD 2 solid-propellant rocket booster, giving a thrust of 3.78 kiloNewton (859 pounds) for 2 seconds, launches the Pioneer. The UA can either land on a runway using a tail-hook to catch an arresting wire or fly into a recovery net (for shipboard recovery). It is equipped with an autopilot, an INS, and a two-way C-band data link. Although it can fly a preprogrammed mission, the usual mode of operation is manual remote control using video provided by the data link. Maximum range of the line-of-sight data link is 185 kilometers (100 nautical miles). It is possible to equip the RQ-2A with a wide variety of mission payloads, the most important being the Wescam DS-12 EO/IR sensor. Typical tasks for the UAS are naval gunfire support, reconnaissance, TA, and BDA.

3-47. After a number of improvements, the latest designation is RQ-2B. This variant is equipped with UAS common automatic recovery system; modular integrated avionics group; and a new Unmanned Aerial Vehicle Engines Limited, United Kingdom AR-741 rotary engine. Thirty-three older RQ-2As have received upgrades to RQ-2B standard.

3-48. At the time of this writing, six Pioneer systems are still in service with the Navy and Marine Corps. The [RQ-8A Fire Scout](#) vertical takeoff unmanned aerial system will replace the RQ-2B.

UTILIZATION

3-49. Pioneer conducts reconnaissance, surveillance, TA, and BDA missions. Pioneer provides the tactical commander with NRT imagery intelligence to enable force deployment decisions. Pioneer has become an at-sea requirement for shipboard deployments. Proven capabilities of Pioneer are—

- Shipboard/land-based operations.
- Target location, verification, and selection.

- Naval surface fire support.
- BDA.

SPECIFICATIONS

3-50. See table 3-5 for RQ-2A data.

Table 3-5. RQ-2A data specifications

<i>Design Feature</i>	<i>Specification</i>
Length	4.27 m (14 ft)
Wingspan	5.15 m (16 ft 10.75 in)
Height	1.00 m (3 ft 3.5 in)
Weight	Max: 205 kg (450 lb) Empty: 178 kg (392 lb)
Speed	Max: 204 km/h (127 mph) Cruise: 120 km/h (74 mph)
Ceiling	4,570 m (15,000 ft)
Range	185 km (100 nm)
Endurance	5 hours

RQ-8B FIRE SCOUT

3-51. The RQ-8B (figure 3-9) incorporates a four-bladed rotor system based on the Schweizer Model 333 manned commercial light helicopter. The Fire Scout has an endurance level of more than 8 hours with a 130-pound payload. A derated Rolls T-Royce/Allison turbo shaft engine powers the UA with folding blades that allow for compact stowage of the UA. The Fire Scout is equipped with a GPS-based navigation system for autonomous operations, and the GCS can control three UA simultaneously. The LOS range of the Ku-Band TCDL is about 280 kilometers (150 nautical miles). The mission payload is an integrated EO/IR laser designator and rangefinder (LDRF) system. The Navy RQ-8A with a three-bladed rotor system has already carried a 430-pound combination payload that included SAR, EO/IR/laser rangefinder and designator, and communications relay. Northrop Grumman plans company-funded weapons trials with the unmanned helicopter launching rockets and Viper Strike (GBU-44/B). The RQ-8B can downlink imagery from 20,000 feet out to 150 nautical miles from its ground station.



Figure 3-9. Fire Scout RQ-8

UTILIZATION

3-52. Fire Scout is fully autonomous, requiring limited operator intervention, and designed to provide SA and precision targeting support for the Navy and Marine Corps.

SPECIFICATIONS

3-53. See table 3-6 for RQ-8B data.

Table 3-6. RQ-8B data specifications

<i>Design Feature</i>	<i>Specification</i>
Length	6.98 m (22 ft 11 in)
Rotor diameter	8.38 m (27 ft 6 in)
Height	2.87 m (9 ft 5 in)
Weight	Max: 1400 kg (3,087 lb) Empty: 661 kg (1,457 lb)
Speed	> 231 km/h (144 mph)
Ceiling	6,100 m (20,000 ft)
Endurance	>8 hours
Propulsion	Rolls-Royce/Allison 250-C20W turbo shaft; 175 kw (235 shaft horsepower [shp])

SECTION IV—MARINE CORPS

FQM-151 POINTER

3-54. The FQM-151A (figure 3-10) is a simple single-boom parasol sailplane configuration. Powered by a 300-watt electric motor, the UA uses the primary lithium sulfur dioxide or nickel cadmium rechargeable batteries. Upgraded Pointers have a GPS-based auto navigation unit to allow autonomous waypoint navigation and loitering functions. Transported in backpacks, the UA and GCU each weighs about 22 kilograms (50 pounds). The Pointer is hand launched and lands on its belly after flown into a deep stall after engine shutdown. It is possible to equip the FQM-151A with either a color or night vision camera. The GCU consists of two units with the operator having a display and control box to fly the vehicle using the video from the camera. The second operator has a hand-held display and VCR unit, and a microphone to record commentary on the observed video picture.



Figure 3-10. Pointer FQM-151

UTILIZATION

3-55. The FQM-151 Pointer is a small hand-launched UAS used for real-time video surveillance. Deployed in various U.S. operations, including the Gulf War and OEF, Pointers have performed R&S missions.

SPECIFICATIONS

3-56. See table 3-7 for FQM-151A data.

Table 3-7. FQM-151A data specifications

<i>Design Feature</i>	<i>Specification</i>
Length	1.83 m (6 ft)
Wingspan	2.74 m (9 ft)
Weight	4.3 kg (9.6 lb)
Speed	80 km/h (43 kt)
Ceiling	300 m (985 ft)
Mission Radius	5 km (2.7 nm)
Endurance	Primary batteries: 60 minutes Rechargeable batteries: 20 minutes
Propulsion	Electric (samarium cobalt) motor; 300 watt

DRAGON EYE

3-57. A Dragon Eye system consists of the three UA (figure 3-11) and ground control equipment. All components are lightweight (2.3 kilograms [5 pounds] for one UA, 5.4 kilograms [12 pounds] for the GCS) and are carried in a soldier's backpack. Powered by an electric motor, the UA has two wing-mounted driven propellers. The UA is hand launched or launched with the help of a bungee cord, and is recovered by an autopilot-controlled belly landing. The ground control equipment includes a laptop computer, used to program waypoints into the Dragon Eye's GPS navigation system. The UA flies its mission fully autonomous, but the operator can optionally update the waypoints during flight. The Dragon Eye is equipped with interchangeable nose assemblies, which house different types of side-looking motion cameras—full-color daylight EO or low-light monochrome cameras. The operator receives real-time down linked camera imagery. Special goggles are required to view the video.

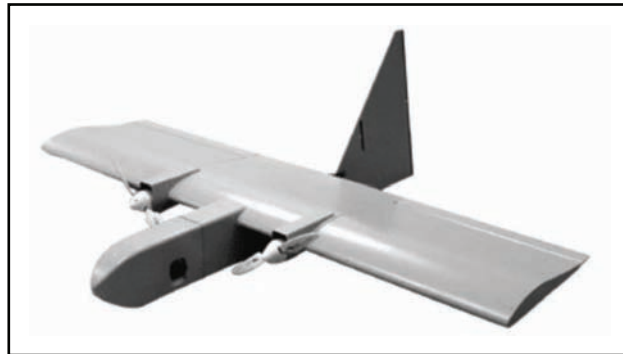

Figure 3-11. Dragon Eye UA

UTILIZATION

3-58. Dragon Eye provides maneuver company commanders with real-time information. Company commanders can view an area over a hill or in a valley or wadi (dry waterbed) without exposing their position or personnel.

SPECIFICATIONS

3-59. See table 3-8 for Dragon Eye data.

Table 3-8. Dragon Eye data specifications

<i>Design Feature</i>	<i>Specification</i>
Length	0.91 m (2 ft 11.75 in)
Wingspan	1.14 m (3 ft 9 in)
Weight	2.3 kg (5 lb)
Speed	65 km/h (40 mph)
Ceiling	150 m (500 ft)
Range	10 km (6 mi [miles])
Endurance	1 hour
Propulsion	Electric motor

SILVER FOX

3-60. The Office of Naval Research (ONR) originally developed the Silver Fox (figure 3-12) reconnaissance UAS in 2002 to spot whales in naval operating areas before beginning a naval exercise. The Marine Corps asked ONR to build Silver Fox systems for use as tactical reconnaissance, intelligence, surveillance and target acquisition UAS for small units.

3-61. The Silver Fox is of modular construction and powered by a small piston engine of model airplane design. It can be equipped with straight wings of various sizes, allowing for selectable tradeoffs in time-on-station and payload weight versus speed. The 10-kilogram (22-pound) UA can be hand launched, but normally a compressed-air driven launcher is used. It is equipped with a GPS navigation system to fly fully autonomous missions of up to 10 hours in duration. The mission is preplanned using the laptop computer of the GCS. The 32-kilometer (20-mile) range of the system's LOS data link determines operational radius of the baseline UAS. The current Silver Fox developmental vehicles are equipped with IR and high-resolution color zoom video cameras that send their imagery in real time to the operator's display screen.

However, the vehicle could also employ other sensors with a weight of up to 1.8 kilograms (4 pounds) in its payload section.



Figure 3-12. Silver Fox UA

UTILIZATION

3-62. Silver Fox relays information instantaneously to a remote laptop computer that provides intelligence for advancing Marines. Silver Fox can determine what lies beyond the next hill or hiding in an ambush position, or gather battlefield information.

SPECIFICATIONS

3-63. See table 3-9 for Silver Fox data.

Table 3-9. Silver Fox data specifications

<i>Design Feature</i>	<i>Specification</i>
Length	1.5 m (5 ft)
Wingspan	1.14 m (3 ft 9 in)
Weight	10 kg (22 lb)
Speed	105 km/h (65 mph)
Ceiling	300 m (1,000 ft)
Range	32 km (20 mi)
Endurance	10 hours
Propulsion	Model airplane engine

SCAN EAGLE

3-64. Scan Eagle (figure 3-13) is a tailless aircraft with slightly swept wings of high aspect ratio. A tail-mounted, two-stroke, gasoline-fueled, off-the-shelf model aircraft engine powers it. The UA is pneumatic catapult launched and recovered automatically by a sky hook system, where a rope hanging from a 15-meter (50-foot) pole catches the UA. Scan Eagle is equipped with a GPS-based navigation system for flying autonomous missions along predefined waypoints and an inertial stabilized sensor turret. Standard payload is either an EO or an IR camera. The UAS operator views the camera images in real time and can point and lock the camera on specific targets.



Figure 3-13. Scan Eagle

UTILIZATION

3-65. Scan Eagle performs the following missions:

- ISR.
- Communications relay.
- TA.
- Target laser illumination.
- Search and rescue.
- Drug interdiction.
- Geomagnetic and atmospheric surveys.
- Coastal patrol.

SPECIFICATIONS

3-66. See table 3-10 for Scan Eagle data.

Table 3-10. Scan Eagle data specifications

<i>Design Feature</i>	<i>Specification</i>
Length	1.19 m (3.9 ft)
Wingspan	3.05 m (10.0 ft)
Weight	18 kg (40 lb)
Speed	120 km/h (75 mph)
Ceiling	4,880 m (16,000 ft)
Endurance	> 15 hours
Propulsion	2-stroke piston engine; 1.1 kW (1.5 hp)

SECTION V—COAST GUARD

EAGLE EYE

3-67. The Eagle Eye (figure 3-14) is now part of the United States Coast Guard's Integrated Deepwater System. This integrated homeland defense system is geared toward modernizing the service's coastal-security hardware by replacing aging cutters and aircraft while upgrading and improving command, control, and logistics systems.

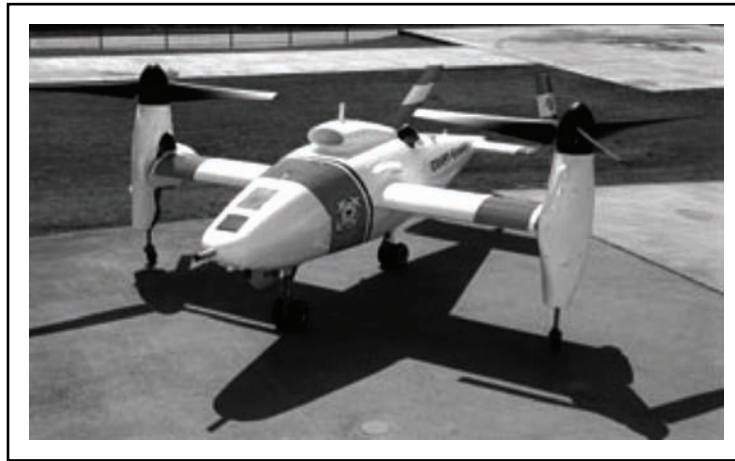

Figure 3-14. Eagle Eye

UTILIZATION

3-68. The Coast Guard's IDS design meets the following future maritime needs.

- Homeland security necessitates pushing America's maritime borders outward, away from ports and waterways to implement layered, maritime security operations.
- Maritime domain awareness (MDA)—knowledge of all activities and elements in the maritime domain—is critical to maritime security. IDS is a critical enabler for enhancing current MDA and developing a far more robust and effective system.
- A network-centric system of command, control, communications, computers, intelligence, surveillance, and reconnaissance is required for effective accomplishment of all Coast Guard missions.
- Interdiction of illegal drugs, migrants, and protection of living marine resources.

SPECIFICATIONS

3-69. See table 3-11 for Eagle Eye data.

Table 3-11. Eagle Eye data specifications

<i>Design Feature</i>	<i>Specification</i>
Length	5.46 m (17 ft 11 in)
Wingspan	4.63 m (15 ft 2 in)
Main Rotor Diameter	3.05 m (10 ft)
Payload	91 kg (200 lb)
Maximum Takeoff	1,023 kg (2,250 lb)

Table 3-11. Eagle Eye data specifications

<i>Design Feature</i>	<i>Specification</i>
Speed	360 km/h (225 mph)
Ceiling	4,420 m (14,500 ft)
Range	100 nm
Endurance	4 hours
Propulsion	1 × Allison 250-C20B , 375 shp (280 kW)

SECTION VI—SPECIAL OPERATIONS COMMAND

CQ-10 SNOWGOOSE

3-70. In 2003 the United States Special Operations Command bought five Snow Goose aerial cargo delivery UAS from the Canadian company Mist Mobility Integrated Systems Technology (MMIST). The Snow Goose (figure 3-15 and figure 3-16) UAS, officially designated CQ-10A by the DOD, is an application of MMIST's Powered Sherpa self-propelled autonomous GPS-guided parafoil delivery system.



Figure 3-15. Snow Goose CQ-10 in flight



Figure 3-16. Snow Goose CQ-10 displayed on vehicle

3-71. The CQ-10A vehicle consists of a central fuselage module that houses payload and fuel, the GPS-based navigation and control system, and the single piston engine driving a pusher propeller. Attached to this module are landing skids and the parafoil canopy. The cargo and fuel compartment design of the Snow Goose allows the user to trade cargo capacity for more endurance and conversely. Maximum combined cargo/fuel weight is about 270 kilograms (600 pounds). Personnel program and upload the flight plan into the UA's guidance system before launch using an industry standard laptop computer. The Snow Goose conducts its mission completely autonomously, and can land at its destination point or drop supplies from the air and return to base.

UTILIZATION

3-72. Snow Goose deployment occurs by airdropping from a C-130 or C-17 aircraft or launching off the back of a HMMWV for the purpose of pinpoint delivery of supplies to special operations forces. Possible Snow Goose missions include dropping leaflets and delivering small amounts of ammunition, medical supplies, and other equipment.

SPECIFICATIONS

3-73. See table 3-12 for CQ-10A data.

Table 3-12. CQ-10A data specifications

<i>Design Feature</i>	<i>Specification</i>
Length	9 ft 6 in
Parafoil span	400 to 900 sq ft (square feet) (payload based)
Weight	Max: 540 kg (1,200 lb) Empty: 270 kg (600 lb)
Speed	50 km/h (31 mph)
Ceiling	5,500 m (18,000 ft)
Range	300 km (160 nm) (34 kg [75 lb] payload)
Endurance	10 hours
Propulsion	Rotax 914 piston engine
Payload	91 kg (200 lb)

FQM-151 POINTER

3-74. The FQM-151 Pointer (figure 3-17) is a small hand-launched UAS used for real-time video surveillance. The United States Special Operations Command (USSOCOM) adopted the system in fiscal year 2003. Twenty systems were fielded to USSOCOM. Upgraded Pointers now have a GPS-based auto navigation unit, allowing autonomous waypoint navigation and loitering functions. Pointer has the ability to carry a two-pound payload consisting of either a color television camera or an IR imager (Indigo Alpha) for real-time, high-resolution video imagery.



Figure 3-17. FQM-151 Pointer

UTILIZATION

3-75. The FQM-151 Pointer is used in support of the global war on terrorism.

SPECIFICATIONS

3-76. Refer to paragraph 3-56 and table 3-7 for Pointer specifications.

RQ-11 RAVEN

3-77. Similar to the FQM-151 Pointer (figure 3-17), the Raven (figure 3-18) is also a small hand-launched UAS used for real-time video surveillance. Adopted by USSOCOM in fiscal year 2004, Raven provides the small unit member with real-time intelligence for over the hill or targets up to 10 to 15 kilometers away. Raven will replace the Pointer system as Pointers on-hand age and become unusable.



Figure 3-18. Raven UA

UTILIZATION

3-78. USSOCOM uses the Raven for reconnaissance, surveillance, and remote monitoring.

SPECIFICATION

3-79. Refer to paragraph 2-37 and table 2-8 for Raven specifications.

DRAGON EYE

3-80. Refer to paragraph 3-57 and figure 3-11 for Dragon Eye description.

UTILIZATION

3-81. USSOCOM uses the Dragon Eye for reconnaissance and surveillance and remote monitoring.

SPECIFICATIONS

3-82. Refer to paragraph 3-59 and table 3-8 for Dragon Eye specifications.

This page intentionally left blank.

Chapter 4

Unmanned Aircraft System Mission Planning Considerations

SECTION I—OVERVIEW

4-1. The capabilities of UAS expand the planning time for the S2 and S3. Conversely, there is the potential for over reliance on UAS at the expense of other collection assets. This can result in an ISR plan neither comprehensive nor integrated. All intelligence-gathering assets require equal consideration and emphasis when developing a focused ISR plan that meets the commander's critical information requirements (CCIR). Collection efforts are maximized when tactical UAS units are in a DS role to the BCT.

4-2. The planning process for UAS operations does not differ from the doctrinal processes already in place. When UAS support units that do not have habitual relations, it is critical the supporting and supported units coordinate for mission planning, execution, and A2C2. The UAS LNO facilitates the flow of information between UAS operations and the supported unit and ensures the supported unit understands UAS capabilities and limitations. This is normally a function of the UAS operations officer (150U). If an individual is not available, organic planners still must plan missions to the same level and detail expected of a system subject matter expert.

4-3. For any mission, the commander seeks to establish criteria that maximize his probability of success. Therefore, similar criteria must be set before launching an UA. The supported commander, with recommendations from the UAS headquarters, sets these criteria. A result of the planning process must be quantified mission criteria stated in easy to understand terms. For any stated criteria not achieved before or during the mission, the appropriate commander should execute predetermined actions, such as delaying or terminating the mission.

4-4. UAS contribute to the overall ISR effort. The UA's range and endurance provide commanders with a bird's-eye perspective, when and where they need it, without risking manned aircraft. UA can fly deep into the area of operations (AO) and are flexible enough for dynamic retasking to provide timely information on other areas.

4-5. Ongoing deployments and combat operations provide keen insights into the broad range of future missions and requirements. The Army is fighting in a distributed manner on a noncontiguous battlefield with smaller, more effective units and at an increased operating tempo. Incorporated UAS units enhance joint and combined arms capabilities at the lowest level. This requires UAS leaders at all levels to be well versed in battle tasks across all Army warfighter functions.

4-6. The fundamental support Army UAS most commonly provide is—

- Reconnaissance: NRT combat information about terrain, friendly unit actions, and the disposition of possible enemy elements.
- Surveillance: area surveillance in friendly or enemy territory.
- Situational Awareness: provide commanders with SA/situational understanding (SU) and mission planning information
- Security: reaction time and maneuver space for the main body and area security.
- Targeting: TA, target detection and recognition, target designation and illumination, and BDA.

- Communication support: voice and data communications retransmission (RETRANS)
- Movement support: convoy security, mine/IED detection

4-7. Even UAS with degraded mission packages can disrupt enemy operations. Enemy concerns about UAS activity cause frequent movement and tend to generate increased communications between organizations that provide SIGINT data. Frequent movement disrupts the enemy force's ability to conduct coordinated operations, strains its logistics system, and degrades personnel's physical and mental endurance.

4-8. Depending on the type of UA and its altitude, the UA can also alert the enemy to the presence of friendly forces when conducting reconnaissance, surveillance, and security missions.

4-9. UAS may perform multiple roles during their long missions. The supported commander determines the mission statement, which may include many of the above roles in the mission statement, and specifies "be-prepared" contingency roles so the correct payload is onboard. Some sensor packages are compatible with multiple roles. Multiple sensors may exist on the same UA.

SECTION II—EMPLOYMENT CONSIDERATIONS

4-10. The importance of the mission drives the abort criteria. While some operations may depend on the success of a UAS mission, other operations may be augmented with additional assets that can fill the void if the UAS is unable to complete its mission. Personnel derive mission abort criteria from the commander's intent and the implied importance of the mission. Terminating less critical UAS support missions sooner than ground missions requiring critical UAS support may be considered. The ground commander must decide the level of criticality placed on the support requested from organic or supporting UAS assets.

4-11. Planning considerations for employing UAS are similar to those of ground units and are nearly identical to those of manned aviation assets. The primary difference between employing ground units and employing Army UAS is the UAS's ability to exploit the third dimension. With this capability comes a responsibility for maintaining separation between Army UAS and other systems, both manned and unmanned, competing to use the same airspace.

4-12. Planning considerations are METT-TC dependent. Some elements are specific to the mission and discussed in the appropriate section of this manual. This section addresses planning considerations common to the employment of most Army UAVSs.

LOCATION OF UNMANNED AIRCRAFT SYSTEMS

4-13. UAS support combat operations anywhere on the battlefield to include forward of the forward line of own troops (FLOT). They provide imagery day and night, when equipped with the proper sensors. UAS are an excellent imagery asset providing the commander with NRT reconnaissance and battlefield surveillance without the possibility of risk to a manned UA. They give commanders a dedicated and rapidly taskable asset that can look wide as well as deep. During a preplanned UAS mission, changes in mission priorities or identification of new targets may occur. The commander can then redirect an UA to support a different mission or observe another area in real time.

4-14. UAS units can launch UA from either improved or unimproved airstrips. Small UAS, such as Raven, are hand launched. Locating a GCS with the supported unit generally improves coordination because the UAS section has immediate access to AD status, threat graphics, and weather data. Use of all-source analysis system—light, aviation mission planning system/portable flight planning system (PFPS), and blue force tracking (BFT) can further expedite coordination. UAS elements can operate in single or split-site configurations.

SINGLE-SITE OPERATIONS

4-15. In single-site operations, the entire UAS unit is collocated. Single-site operations allow for easier unit command, control, and communications (C3), and logistics. However, coordination with the supported unit may be more difficult owing to distance from and communications with the supported unit. In addition, single-site operations emit a greater electronic and physical signature.

SPLIT-SITE OPERATIONS

4-16. In split-site operations, the UAS element is typically split into two distinct sites—the mission planning and control site (MPCS) and the L/R site. The MPCS is normally located at the supported unit's tactical operations center (TOC) or forward command post (CP) location. The L/R site is normally located in the supported unit's rear area. This method is not applicable for Raven operations owing to its small team size.

Mission Planning and Control Site

4-17. The MPCS consists of the GCS/GCU, GCS personnel, and supporting equipment. The MPCS receives the tasking, plans the mission, takes control of the UA for the actual conduct of the mission, and reports information.

Launch and Recovery Site

4-18. The L/R site consists of UA, L/R systems, GCS, maintenance equipment, GSE, and supporting personnel. The L/R site receives the mission from the MPCS. It prepares and launches an UA. After the UA has reached a predetermined altitude, the GCS at the supported unit's location receives control of the UA. For recovery of the UA, the process is reversed. Units should consider the following when selecting the L/R site:

- The distance and LOS to possible target areas.
- Adequate space for system L/R or engineer support (construction and expansion of site).
- The L/R area should afford sufficient obstacle clearance to make takeoffs and landings (see applicable system specifications for obstacle clearance requirements).
- Avoid areas with high population densities and multiple high-power lines, when possible. Operations in these areas add additional risk factors to the mission.
- Avoid areas with high concentrations of communications equipment and transmitters, which may interfere with UAS control.
- The site should be close enough to MPCS to effectively communicate, handover, and receive control of the UA.
- Site selection should incorporate operations security (OPSEC) considerations to reduce the possibility of detection and destruction by enemy forces.
- If the UAS L/R site is collocated with manned aircraft operations, the parking plans and flight traffic patterns must be deconflicted.
- The proximity to GSE (for example, the GDT and generators). In addition to the physical limitations of cables and other equipment, personnel must consider other areas such as noise abatement and security.

Raven Rooftop Operations

4-19. Rooftops generally make ideal Raven SUAS control sites. The higher elevation of the uplink and downlink antennas significantly increases the GCU LOS performance. This equates to better range and signal performance. To realize the benefits of rooftop operations, a building should be higher than surrounding buildings and terrain. A secondary benefit to operating from rooftops is obstacle clearance for

zero wind launches. A properly executed rooftop launch provides more distance for the air vehicle to settle without risk of impacting obstacles. The RVT may also be remoted to the rooftop of a TOC or TAC housed in a structure.

SUSTAINED OPERATIONS

4-20. UAS are reliant on their crew to operate. Local policy and AR 95-23 establishes limits on crew duty days, as well as periods of flight during that day.

4-21. Under normal conditions, the UAS aerial reconnaissance company can provide two RQ-5 missions of 8 hours coverage, and a single I-Gnat mission of 20 hours coverage.

4-22. Under surge operations, the UAS aerial reconnaissance company can provide 12 hours for 6 days followed by 1 day of maintenance and crew reparative measures.

4-23. Under normal conditions, the UAS aerial reconnaissance platoon (RQ-7 Shadow) can provide a routine 12 hours on station at a range of 50 kilometers.

4-24. Under surge operations, the UAS aerial reconnaissance platoon can provide 18 hours for a 72-hour period.

4-25. If possible, duty day changes should be kept to a minimum. In the dynamic battlefield, schedule flexibility must follow the example below (figure 4-1) (based on a mission coverage time of 1800z to 0600z and a preplanned flight time of 1800z to 0200z). The example pertains to a single flight crew.

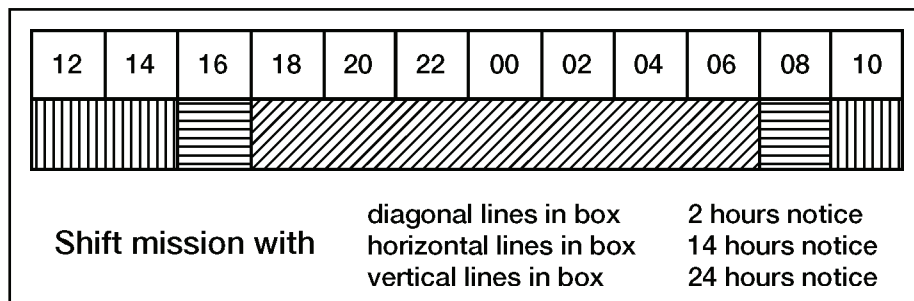

Figure 4-1. Schedule template

4-26. During outstation operations, allow the crew 12 hours between off-station and on-station times to allow for the mission planning and transfer of aircraft to the forward GCS.

TERRAIN AND WEATHER

4-27. Terrain includes not only natural but also manmade features such as cities, airfields, bridges, railroads, ports, power and telecommunications transmission lines, and towers. Terrain plays a key role in both sensor effectiveness and command and control. Open, desert terrain provides optimal conditions for UAS sensors to locate enemy activity; mountainous, heavily vegetated terrain greatly reduces sensor effectiveness. Similarly, flat terrain eases LOS issues whereas mountainous terrain may force commanders to set up multiple GCSs or sacrifice the range of their UAS.

4-28. To find tactical advantages, commanders and staffs must analyze and compare the environmental limitations of the UA and mission packages against the enemy's ability to detect and successfully engage the UA.

4-29. AR 95-23, host nation, and local regulations set the minimum weather conditions, stated as ceiling and visibility, for UAS operations. Weather conditions must be at or above those minimums the entire time

aircraft are flying and over the entire mission area in which they are operating, unless the appropriate approval authority waives or approves deviation due to criticality of a specific combat operation.

4-30. System/aircraft avail weather is a primary concern, as it is for all flight operations, but there are some special considerations for UAS (see table 4-1). Meteorological factors not only influence the performance of the UA, but also the payload. Commands anticipating UAS support for wartime contingencies or exercises must research the AO for data on meteorological trends. This information provides an accurate standard of anticipated UAS coverage.

PRECIPITATION, WIND, AND TEMPERATURE

4-31. Precipitation, winds, and temperature all degrade the operating parameters of UAS, but icing presents a major dilemma. No UA in the Army inventory possesses a deicing capability. When UA are operating in temperatures within five degrees Celsius of freezing and in visible moisture, ice develops on the wings and fuselage, increasing drag and weight. When the operator notes the first effects of icing, the operator will maneuver the UA out of and away from the icing environment. One possible action is to reduce altitude if possible.

4-32. Crosswinds in excess of specific UA limitations create dangerous conditions for takeoff and landings. A L/R site with a crosswind runway can overcome this limitation.

4-33. High winds, UA specific, at operating altitudes also create dangerous flying conditions. UA can operate in light rain. Light rain does degrade the quality of the UAS imagery, but the product is still exploitable. Precipitation does not drastically degrade operations at a GCS, but protects portable systems exposed to the elements. Commanders must closely monitor the L/R site to confirm runways/landing areas are suitable for UAS operations.

FOG AND LOW CLOUDS

4-34. Fog and low cloud ceilings primarily reduce the effectiveness of the payloads. The IR camera can easily penetrate light fog, but cannot penetrate heavy fog or clouds. To collect needed exploitable imagery, UA must fly lower, increasing their potential for detection and exposure to enemy air defense artillery (ADA) gun systems. In addition, fog makes landing extremely difficult.

Table 4-1. Weather limitations

Weather	UAS	UAS Sensors
Icing	No deicing/anti-icing capability. Flights prohibited if icing forecasted/known.	N/A
Crosswinds > 15 kt	Exceeds operational capabilities.	N/A
High winds at altitude > 50 kt	Creates dangerous flying conditions.	N/A
Light rain	UAS can operate.	Degrades quality of imagery, but product may be exploitable.
Heavy rain: 2 inches per hour or more	UAS can operate.	Poor, unusable imagery.
Fog and low clouds	UAS can operate, but increases the risk to the UA during takeoffs/landings.	Penetrate heavy fog/clouds.

SENSOR CONSIDERATIONS

4-35. The MC selects the type sensor that provides the best resolution and image for the mission. Weather conditions, temperature, and time of day are a few of the variables considered in selecting the best sensor option. Table 4-2 is a matrix of sensor advantages and disadvantages for the types of sensors currently available on UAS.

Table 4-2. Sensor matrix

<i>Advantages</i>	<i>Disadvantages</i>
<i>Electro-Optical</i>	
Affords a familiar view of a scene.	Employment of camouflage and concealment techniques can deceive the sensor.
Offers system resolution unachievable in other optical systems or in thermal images and radars.	Restricted by weather conditions; visible light cannot penetrate clouds or fog.
Preferred for detailed analysis and measurement.	Restricted by terrain and vegetation.
Offers stereoscopic viewing.	Limited to daytime use only.
<i>Infrared</i>	
A passive sensor and is impossible to jam.	Not as effective during thermal crossover (1 to 1.5 hours after sunrise or sunset).
Offers camouflage penetration.	Tactical platforms threatened by threat air defenses.
Provides good resolution.	Bad weather degrades quality.
Nighttime imaging capability.	

THREAT CONSIDERATIONS

ENEMY

4-36. Army UAS are often difficult to detect when employed properly, and once detected are difficult to destroy because of their small signatures. Even so, hostile fire may damage or destroy Army UAS. Enemy activity along flight routes or in the restricted operations zone (ROZ) may result in extensive friendly losses or require mission termination.

4-37. Currently, tactical UA are difficult for enemy AD systems to detect and engage. However, once engaged, the UA is relatively easily destroyed or rendered nonmission capable. Enemy radars by design detect much faster moving aircraft and tend to skip over these slow-flying platforms. If detected, the composite airframes provide small radar cross sections. IR-guided SAM systems have difficulty obtaining a positive lock on the small power plants and, in most cases, cannot engage them. The low visual and lower acoustic signatures of UA make them an attractive platform for stealth reconnaissance.

RULES OF ENGAGEMENT

4-38. Rules of engagement (ROE) specify the circumstances and limitations under which forces initiate and (or) continue combat engagement with other forces encountered. United States Armed Forces always comply with the ROE, also known as the law of war and the law of armed conflict. In those circumstances when armed conflict under international law does not exist, the application of ROE principles nevertheless exists as a matter of national policy. If armed conflict occurs, ROE governs the actions of U.S. Forces. Many factors influence ROE, including national command policy, mission, operational environment, commander's intent, and international agreements regulating conduct. ROE always recognize the inherent right of unit and individual self-defense. Properly developed ROE is clear, situation dependent, reviewed for legal sufficiency, and included in training. ROE typically varies from operation to operation and may change during an operation.

DOWNED UA RECOVERY OPERATIONS

4-39. See appendix D for a discussion of downed UA planning and recovery operations.

TIME/RESOURCES AVAILABLE

SYSTEM/AIRCRAFT AVAILABLE

4-40. If there are maintenance issues with the GCS or the mission requires more UA than are available (owing to combat loss, nonmission-capable equipment, or lack of crews), the commander may have to terminate the mission.

Lack of Mission-Essential Combat Power

4-41. The lack of mission-essential combat power could be the result of increased enemy or decreased friendly capability. If the UA meets stronger than expected AD threat or loses direct fire or surveillance assets en route, the commander may request additional support, or modify or terminate the mission.

Troops and Support Available

4-42. Before launching any UAS mission, commanders must assess the training and readiness level of friendly forces. The analysis includes availability of critical systems, supporting fires, and joint support. They must examine the availability of combat and sustainment assets, including contractors required to conduct the UAS mission.

Supporting Fires

4-43. The supported unit will frequently have access to indirect fires from a coordinated fires network. These complementary fires could facilitate movement to the objective area through joint suppression of enemy air defense (J-SEAD), engage targets bypassed by UA, or indirect fires on the objective. Knowing what and when FS is available are important considerations during UAS mission planning and engagement area development. Efforts to coordinate joint fires for actions on the objective could be critical toward success for operations in deep areas. With the application of LRF/D on UAS mission equipment packages, coordination of supporting fires will become a routine part of UAS premission planning.

TIME AVAILABLE

4-44. Commanders assess time available for planning, preparing, and executing the mission. Other time considerations necessary for planning UAS missions include obtaining authorization to launch the UA into airspace, flying to the mission area, determining the maximum time the UA can stay on station, receiving and analyzing UAS data, completing follow-on system maintenance, and so forth. They consider how friendly and enemy forces will use time and the possible results. Proper use of time available can be a key to success. Because of the added complexity in planning UAS operations compared to normal ground operations, commanders use the one-third, two-thirds rule whenever possible. Concurrent planning makes the best use of time, and emerging digital systems enhance concurrent planning capabilities.

4-45. Planning times are critical for every type of military mission, including UAS operations. UA move rapidly, so the tendency may exist to give UAS units short-notice missions to exploit their ability to reach the mission area quickly. However, sufficient planning time is essential for optimal UAS utilization. Time is required to evaluate the threat, select and possibly transfer the appropriate payload to a mission capable UA, plan navigation routes and altitudes, clear routes, coordinate airspace, and brief UAS operators. Warning orders (WARNOs) and fragmentary orders (FRAGOs) maximize time available by allowing subordinate units to prepare for pending action. Unit standing operating procedure (SOP) and prior training

in UAS operations involving supported and supporting units simplifies UAS mission planning and execution.

Warning Order

4-46. A WARNO is a preliminary notice of an order or action to follow. It is a planning directive that describes the situation, allocates forces and resources, establishes command relations, provides other initial planning guidance, and initiates subordinate unit mission planning. Planning and coordination begin when the unit receives a WARNO. The UAS commander, LNO, or a staff officer may go to a supported commander's headquarters to assist in UAS support planning. A timely WARNO also allows UAS units to begin reconfiguring payloads or preparing to reposition to support the upcoming operation, including altering fighter management cycles and analyzing specific areas within the AO.

Fragmentary Order

4-47. A FRAGO is a mid-mission change or modification of original orders. Because of the long endurance of most UA, a FRAGO is the most common procedure for changing mission priorities and movement of UAS. Generation of a FRAGO may be due to new UAS support requirements or a change in the priority intelligence requirements (PIR) and CCIR. Rather than dynamic retasking with no additional instructions, a well thought out FRAGO is the preferred method to change ongoing, or initiate new, UAS missions.

DYNAMIC RETASKING

4-48. Given the extended duration of many UAS missions, it is common, despite the extensive planning and coordination required, to receive mission changes after launch. UAS planners and supported units should prepare by creating contingency plans and ensuring appropriate airspace coordination.

4-49. Dynamic retasking to preplanned missions may be necessary because of changes in the ground commander's scheme of maneuver or timeline, in weather in the area of launch and recovery or in the UAS mission area, in the higher headquarters' priority for UAS support to airspace clearances, or in the operational status of the UAS itself. Dynamic retasking generally requires the UAS unit to hastily plan and request approval for the supported unit's requested mission changes. A critical element of the dynamic retasking planning process is the coordination of airspace usage. This process gives UAS units the information necessary to change, cancel, or initiate a UAS mission.

4-50. In many cases dynamic retasking can degrade the original mission while providing incomplete or less critical information during the retasked mission. Inadequate intelligence about threats along the new, and usually inadequately coordinated, route may endanger the UA and threaten both the original and retasked mission. Whenever possible, UAS units should plan to have another UA on standby to launch, coordinate airspace usage, and perform the new mission, thereby allowing execution of the original UAS plan in a timely manner.

4-51. In the event of a request or requirement to change targets during flight, the commander or air battle manager immediately validates the requirement with the following metrics:

- The impact on remaining collection must be determined.
- Priority of dynamic target versus priority of remaining targets.
- Historical success of collection.
- Availability of asset.
- Capability of sensor.
- Exploitation requirements.

- Correlation to PIR.
- Time sensitive/criticality.
- Data link capability.
- Airspace coordination.

4-52. Once accepted, the air battle manager briefs the AMC on the mission and issues a tentative plan that details the change. The AMC must replan the mission and recalculate the flight plan. The air battle manager coordinates with the supported unit to limit/define the extent of the change.

CIVIL CONSIDERATIONS (COMBAT OPERATIONS)

4-53. Civil considerations at the tactical level generally focus on the immediate impact of civilians on current operations; however, they also consider larger, long-term diplomatic, economic, and information issues. This is where civilian or commercial airlines can have an impact on UAS operations. Especially during stability operations and support operations, civilian air traffic can become a central feature of planning. Other questions to consider include—

- Will the host nation allow UAS operations?
- What affect will a UAS mishap have on relations?

SECTION III—MISSION PLANNING PROCESS

4-54. The specific capabilities and limitations of each UAS determine the use of that system within the commander's mission requirements. Each UAS has specific capabilities; however, I-Gnat, Hunter, Shadow, and Raven often perform similar missions, such as route reconnaissance or aerial surveillance. The supported unit commander and staff must determine the requirements for each mission, while the UAS team leader or LNO provides system-specific information to support mission accomplishment. The support commander must provide clearly defined PIR for optimal UAS utilization. For example, providing NAIs with specific criteria suited to the UAS capabilities will make better use of the asset opposed to tasking the UAS to locate and report all enemy activity in zone.

MISSION SUPPORTED UNIT

4-55. Information in the following sections relates to mission planning for use by the supported unit staff and various UAS operational elements. See appendix A of this manual for detailed mission, crew, and flight planning checklists.

SUPPORTED COMMANDER

4-56. The supported commander should consider the planning considerations outlined below for UAS employment. The questions posed are not all inclusive. The intent is to aid a commander in developing specific UAS questions that will help provide direction to his staff for UAS planning and mission execution.

- How many hours of daily UAS operations are available?
- What is required for 24-hour UAS coverage?
- What are the security issues for UAS units/teams?
- What are the weather considerations that will influence UAS operations in the next 24, 48, and 72 hours?
- What are the steps and the time required to affect a UAS mission change?

INTELLIGENCE STAFF OFFICER

4-57. In addition to considerations found above, the S2 should consider the following:

- Is time limited or is information required quickly?
- Is a detailed reconnaissance required?
- Is extended duration surveillance required?
- Is the objective at an extended range?
- Is there a need for target verification?
- Are threat conditions and risk to ground assets high?
- Does terrain restrict approach and observation by friendly ground units?
- Are terrain and weather conditions favorable for UAS employment?

OPERATIONS STAFF OFFICER

4-58. The S3 should—

- Exchange SOPs with supporting UAS elements and review mission essential tasks.
- Orient the UAS unit commander, officer in charge (OIC) or noncommissioned officer in charge (NCOIC) on his elements place and role in the force and operation.
- Establish UAS C2 criteria.

4-59. The S3 ensures synchronized use of the airspace by coordinating with the effects coordinator (ECOORD), brigade aviation officer (BAO), air defense officer-, and UAS LNO. The S3 ensures airspace is sufficient to support all aspects of UAS operations.

4-60. The UAS mission order should include the following information:

- AO for the UAS unit.
- Mission statement.
- Time window for the UAS mission.
- Task organization.
- Reconnaissance objective.
- PIR and intelligence requirements that require an answer.
- Line of departure (LD) or line of contact.
- Initial named areas of interest (NAIs).
- Routes to AO.
- Fire support coordinating measure (FSCM) and airspace control measures (ACMs).
- Communications and logistics support.

ECHELONS ABOVE BRIGADE COMBAT TEAM TASKING AND PLANNING

4-61. Echelons above BCT refer to UAS such as Hunter companies organic to the corps, I-Gnat, and joint UAS. These higher echelon UAS, while not organic to the BCT, support BCT operations through the application of UAS derived intelligence.

4-62. Higher echelon UAS intelligence and SIGINT support planning follow joint and Army military intelligence (MI) planning processes. The corps or division collection manager receives requests for tactical reconnaissance or motion imagery support. When appropriate, the tasking requirements manager selects a UAS for the imagery or other mission. The Assistant Chief of Staff- Operations and Plans (G3) may also specify UAS support for some shaping and other applications.

4-63. The collection manager receives mission requests a minimum of 24 hours before the mission to ensure inclusion in the ACO. During initial airspace coordination, UAS units could request the placement of strip alerts on the ATO for response to an immediate tasking that occurs outside the ATO cycle. The asset manager, normally the UAS company commander, may task a mission for the particular request, or more frequently may modify a currently planned mission to accommodate the new requirement. Dynamic retasking of ongoing missions is a third possibility, depending on the priority of the request.

4-64. All UAS require detailed planning with joint airspace users and controlling authorities to prevent accidents and other unplanned events. Interface with airborne warning and control system (AWACS) aircraft may be essential and confirmation of the systems availability or lack thereof to transmit Modes 3 and 4 identification friend and foe (IFF) from aboard the UA. UAS units and airspace planners should request ACMs that maximize the flexibility of the UAS unit to support changes of mission. Refer to FM 3-52 of this manual for further guidance on airspace and A2C2 coordination.

4-65. UAS above BCT level, such as Hunter, Predator, and Global Hawk, operate from fixed wing airfields with improved runways, and each system has its own unique airspace and climb out considerations. A thorough level of A2C2 planning for manned/unmanned flights around both military and civilian airspace is essential in peacetime as well as during support of combat operations.

BRIGADE AND BELOW PLANNING RESPONSIBILITIES

4-66. For most operations, the supported unit and the UAS unit plan at different levels. The brigade aviation element (BAE) (see appendices D and E) is an aviation planning and coordination cell organic to the BCT that synchronizes aviation operations into the ground commander's scheme of maneuver. Table 4-3 provides a general guide for planning responsibilities.

Table 4-3. Supported unit and UAS unit planning responsibilities

<i>Planning Responsibilities</i>	
<i>Supported Unit Provides the UAS Unit</i>	<i>UAS Unit Determines</i>
General timelines	Exact speeds, routes, flight modes and timings
H-hour (line of departure [LD], landing zone [LZ])	Exact planning times from AA to LD, passage points (PPs), battle position (BP) or ROZ
PP locations	Exact flight route to PP
Suppression of enemy air defense (SEAD)/J-SEAD plan	Adjustments required as LD time nears
Flight axes	Exact flight routes
Named area of interest (NAI)/targeted area of interest (TAI)/DPs	Exact surveillance plan

BRIGADE AND BELOW TASKING/PLANNING

4-67. UAS units supporting BCTs and below frequently team with manned systems to support ground maneuver and FS units. UAS planners may need to assist planners from other mission areas and must have adequate knowledge to plan operations to support a wide variety of unit missions.

4-68. The S2 develops NAIs that aid in focusing collection efforts in a systematic approach to answer PIR, monitor DPs, and locate multiple high value targets (HVTs). UAS can reconnoiter and expand the supported brigade's battlespace for targeting and early warning. UAS also support close combat and assist in security and surveillance of NAIs.

4-69. Whether supporting shaping or close combat missions, an ISR plan that uses other collection assets to cue the UAS optimizes UAS employment. Collection systems, such as joint surveillance target attack radar system (JSTARS), ground surveillance radar (GSR), and Improved Remote Battlefield Sensor System, and SIGINT collectors like Prophet and Guardrail common sensor can provide single-source reports that UAS can confirm to produce true intelligence. Collection systems can locate a potential enemy

force, and then the UAS can detect the enemy element and confirm its composition. UAS, cued by other ISR assets, allow the brigade and below to systematically gain and maintain contact with the enemy well before that enemy can range the brigade main body.

4-70. Many brigades have common ground station (CGS) access to provide JSTARS downlink and UAS imagery/data. The CGS provides the ability to view both JSTARS MTI and SAR imagery and, on another single screen display, the UA's location, where it is looking, and its real-time video feed. The UAS GCS is often nearby, allowing rapid landline interface. Trojan Spirit provides another means to link the GCS and CGS. JSTARS allows the S2 and UAS tasking authority to monitor the big picture and fully integrate the UAS to confirm what the JSTARS detects.

4-71. Trojan Spirit is an Army intelligence communications capability used to support UAS operations, but it is not the only system that can provide communications support. The TSC-143 Tri-band system was another method of video dissemination used during Operation Iraqi Freedom (OIF). Each UAS unit has similar communication requirements and addresses those requirements with specific equipment annotated on that unit's MTOE.

4-72. Another brigade method for using UAS during offensive operations is to exploit the UA's ability to move quickly through a zone and observe successive NAIs in a short time. The brigade ISR plan can use the "waves" of reconnaissance method, in which ground collection assets move forward at different times. This allows information from lead elements to cue follow-on reconnaissance forces and trailing intelligence assets. If brigade UA are in the first wave of reconnaissance in the synchronized ISR plan, followon manned reconnaissance and security assets know where to concentrate their efforts. This UAS "recon push" expedites the brigade's movement through the zone. The UAS reconnaissance, which cues ground and air scouts, allows the brigade to identify the enemy's disposition, determine its weakness, and exploit that weakness.

4-73. Before such an operation, the S2 develops NAIs to confirm or deny the enemy defense. Just before the reconnaissance assets crossing the LD, UA launch to take an initial look at the NAIs. En route to NAIs that correspond to primary routes of advance, UA overfly and examine ground reconnaissance infiltration routes. This allows the UAS to detect any enemy forces or obstacles the ground reconnaissance assets will encounter en route to their observation point (OP). Once on station, the focus of the UA's sensor is on each NAI. After the initial observation, the UA may return to a previously observed NAI to observe possible signs of enemy movement. Because brigade UA flight duration is shorter than larger UA, route planning is critical and must integrate manned reconnaissance routes with UA reconnaissance routes. If possible, the UA should remain on station until the first "wave" of manned reconnaissance assets arrive at their OP locations. This ensures nearly continuous surveillance of NAIs and shortens the window between UA reconnaissance of routes leading to an OP and manned aircraft reconnaissance. It also simplifies handover of any UA-detected targets to the manned reconnaissance and security team.

4-74. On the basis of findings of this initial observation, the S2 may refine the ISR plan to focus collection assets on certain NAIs and less on others, or may redirect to new NAIs. The commander issues a FRAGO to the ISR plan to adjust a tasking. The FRAGO includes information concerning the infiltration route reconnaissance of the second wave of manned and unmanned reconnaissance.

4-75. The MPCS and supported brigade TOC transmit UAS-derived and other combat information and intelligence to ground units currently en route or about to cross the LD, so they can adjust their routes and movement techniques to the threat. Direct contact with the GCS by supported units in flight often results in inefficient use of the UAS. The MC, 150U, and other LNO at the MPCS (where the GCS is located) provide this conduit and allow the aircrew to focus on flying the mission.

4-76. Fire support elements (FSEs) want dedicated UAS for TA and fires, whereas maneuver and intelligence elements want dedicated UAS for RSTA and air to ground engagements using onboard UAS systems. The brigade commander's priorities for UAS support must specify whether ISR or TA has

priority, while allowing the potential for both. The scenarios below outline two approaches for establishing criteria for transition of the UAS from surveillance to targeting.

4-77. During wargaming the battle staff identifies high payoff targets (HPTs). The staff also develops the observer plan to locate and track those HPTs for engagement and BDA. During planning the battle staff prioritizes those sufficiently important HPTs that, if found, will cause UAS operators to track and engage with on call fires. In this approach, the commander consciously accepts risk to the UA and loss of ISR. The target's importance must justify loss of the UA or loss of combat information during targeting. Conversely, UAS operators must know to report but not engage non-HPTs.

4-78. For example, during the planning process, the battle staff identifies SA-9s, self-propelled howitzers, engineer-digging assets, and T-80s as HPTs in that priority. Because the plan incorporates rotary-wing and fixed-wing aviation, destruction of SA-9s sets the conditions for close air support (CAS) and close combat attack (CCA). Regardless of its original mission, when the UAS finds SA-9s, the commander can decide to accept the risk of reducing the collection effort by having the UA stay with the SA-9 until the SA-9's destruction. Here, predetermined criteria established during planning describe when to shift from UAS ISR to UAS targeting.

4-79. An alternate approach is to have the commander specify a time or event during the battle when a transition in UAS priorities will occur. For example, the battle staff determines that following identification and handover of the attacking regiment's second echelon motorized rifle battalion to ground collection or manned ISR forces, substantial time will exist before units can expect arriving follow-on forces. During the wargame, the staff determines that with limited brigade shaping to occur, they can rely solely on JSTARS or other assets to provide early warning of enemy follow-on forces, and can now accept the risk of having the UAS dedicated to supporting CCA targeting. This may mean they transition the UAS from security in depth to targeting in support of decisive operations. If the HPT list identifies enemy artillery, UAS missions may dynamically retask to counterfire and eliminate artillery systems that threaten advancing friendly elements. Given less need to support shaping reconnaissance, the UAS can now focus on finding and targeting HPT artillery.

4-80. For the lowest echelon, UAS supporting battalion and below missions, the battalion S2 uses ISR planning that combines brigade and above level SA with organic scouts and UAS. The battalion employs RVTs to derive information from the brigade UAS. It also employs company and below UAS to "see-over-the-next-hill" and perform more localized ISR and persistent "staring" by UAS at a point where they can observe for longer periods. Persistent stare does not imply constant staring or hovering, but by the recognizable change of selected area or target over a period-of-time. For example, the UAS views an NAI at 0700 with no activity then returns at 0800 and now sees a stationary SA-9. The UAS did not see the SA-9 roll into the NAI, but detection of the enemy occurred through persistent staring at the NAI.

4-81. As with brigade level UAS planning, battalion and below may exploit other sensors and scouts to cue UAS employment.

UNMANNED AIRCRAFT SYSTEM UNIT PLANNING PROCESS

4-82. The air battle manager receives valid requirements from the supported unit, usually in the form of a joint prioritized target list that can affect the synchronization matrix or R&S matrix. The Air Battle Manager analyzes the target list and begins initial planning using the troop leading procedures (see table 4-4). See appendix B, section VII for Raven specific planning information.

Table 4-4. Tasking management responsibilities matrix

Task	Air Battle Manager	Air Mission Commander
Receive and Analyze the Mission	Receive schedule or requirements tasking from supported unit. Determine payload requirement. Determine crew availability and fighter management. Determine aircraft availability.	N/A
Issue the WARNO	Issue DA Form 5484-R, Mission Schedule/Brief (minimum 96-hour outlook). Request ACM, as necessary. Submit schedule for ATO, as necessary.	
Make a Tentative Plan	Macro-plan mission (transit flight time for split-site or split-base, set-up time for air data relay mission, and so forth).	
Initiate Movement	Issue FRAGO to AMC.	Initiate preflight of aircraft Order DD Form 175-1, Flight Weather Briefing, as necessary.
Conduct Reconnaissance (Receive and Analyze the Mission Revisited)	Receive and validate target deck. Attend targeting workgroup, as necessary. Attend combined arms brief, as necessary. Attend supported unit operation order (OPORD), as necessary.	Receive DD Form 175-1. Receive validated target deck. Receive operational graphics, as necessary. Download ATO and ACO (weekly master, daily, and changes), as necessary. Review notices to airmen (NOTAMs), as necessary.

Table 4-4. Tasking management responsibilities matrix

Task	Air Battle Manager	Air Mission Commander
Complete the Plan	Develop prioritized target deck for ad hoc targets. Develop operations schedule. Develop joint air attack team (JAAT) timeline, as necessary. Direct mission planning.	Complete mission planning.
Issue the Order	Brief AMC and validate mission on DA Form 5484-R, Mission Schedule/Brief. Assign risk assessment value (RAV).	Conduct air mission brief. Issue mission support brief ('target pack').
Supervise and Refine	Verify mission planning forms are completed. Update mission-tasking status. Coordinate changes with supported unit(s)/agency(ies). Verify mission objectives are accomplished.	Update system tasking status. Provide imagery products to the air battle manager for exfiltration.

4-83. Each target should have the following information:

- Target name.
- Physical description to aid in acquisition.
- Location in eight-digit Military Grid Reference System.
- Required mission.
- Required product.
- Time sensitivity.
- Intelligence report that cued collection.
- Desired end state/effect.
- Reporting instructions.
- SPINS.

4-84. The target deck is then refined on the basis of the following factors:

- Priority of target.
- Historical success of effort.
- Availability of asset.
- Capability of sensor.
- Exploitation requirements.
- Correlation to PIR.
- Time sensitive/criticality.

4-85. This allocation of resources validates the requirements and forms the basis for the advisory tasking to the platoons. The air battle manager passes the advisory tasking to the supported unit, L/R site, and forward control site (outstation). During outstation operations (split-site or split-base), the forward air battle manager coordinates with the company operations and intelligence cell to prevent duplication of effort and assist in data exfiltration.

4-86. The advisory tasking provides the AMC with a tentative mission profile and planning information in the format of the advisory tasking template (Jaeger R&S matrix). At a minimum, it will contain—

- Mission number (Julian date and 2-digit number).
- Primary objectives (including priority and collection emphasis).
- Time on target (last time information of value and earliest time information of value).
- Exploitation requirements and expected product.
- Payload and sensor requirement.

4-87. AMCs use the advisory tasking as the basis of their mission plan and prepare an operations order and mission briefing. The AMC brief provides operational information to the crew and sensitizes aircrew to the mission requirements.

4-88. The data exploiter (DE)/UAS exploitation team (UET) maintain a mission support briefing (MSB). The MSB is a living document that establishes guidance for target exploitation. The MSB also forms a historical database to measure success of the mission, combining this information into “metrics”, specific parameters for collection. The MSB consists of the following:

- Route overlay for PFPS.
- Target overly for PFPS.
- Any operational overlays and graphics.
- Corrected and validated target deck.
- Multi-user internet relay chat (MIRC) transcript.
- End of mission report.
- Completed target matrix.
- Any requested products.

4-89. The AMC receives a mission briefing and FRAGO from the air battle manager and prepares a tactical flight plan, as well as the route card (using the rq5.frm for PFPS or a similar electronic document).

4-90. The AMC builds a flight plan around multiple objectives (NAIs, target reference points, and so forth) using release points (RPs) (figure 4-2).

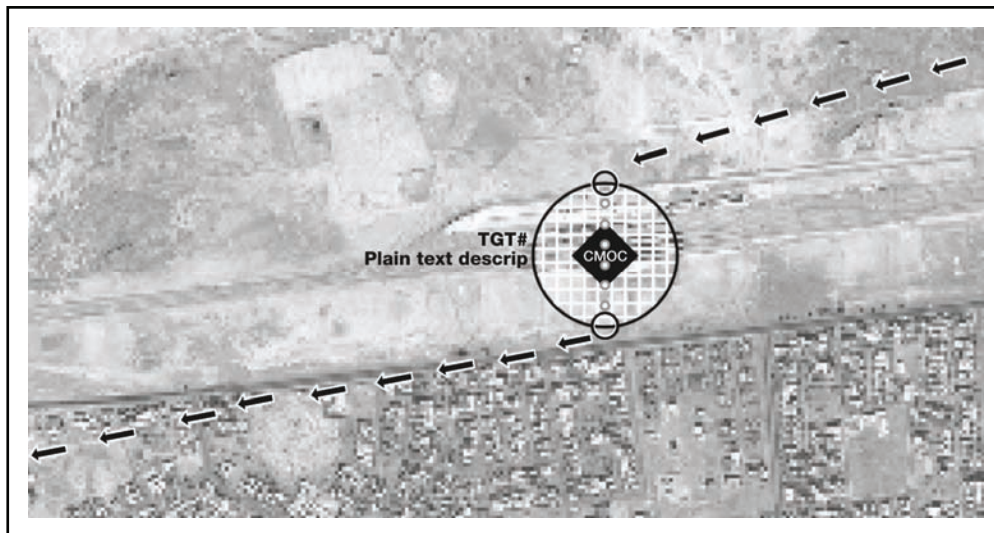

Figure 4-2. Release points

4-91. A RP is a planned location that allows acquisition of a target, and signifies entry into the reconnaissance track. During flight, the AMC must arrive at the RP within +/-5 minutes and +/-500 meters of the target as stated on the tactical flight plan. Unless otherwise directed, the AMC allows 10 minutes for actions on the objective.

POST MISSION ACTIONS

4-92. Mission assessment is a key factor in determining mission success. Accurate feedback will determine whether another mission needs to be executed, a target needs to be attacked again, or if the maneuver commander's conditions have been set to move to the next phase of the operation. It is important that results of the mission assessment not be lost or set aside. Relay and (or) pass on this information to the higher headquarters to assist with the planning and intelligence picture. The mission assessment should focus on enemy action, identified HPTs, BDA, and what was and was not successful during the mission.

4-93. An after action report (AAR) is another important post mission responsibility. An AAR enables units to identify for themselves what happened, why it happened, and how to sustain strengths and improve on weaknesses. The AAR consists of four parts:

- Review the mission as briefed.
- Determine what happened.
- Identify actions to sustain and actions to improve.
- Determine what should be done differently.

4-94. Forward AAR to the next higher headquarters S3. Commanders should ensure all leaders review the AAR and understand the guidance on improving future operations. Following the reviews and commander's guidance, the recommendations should be made readily accessible for reference when planning future operations.

SECTION IV—ARMY AIRSPACE COMMAND AND CONTROL

4-95. Airspace management prevents mutual interference from all users of the airspace, facilitates AD identification, and accommodates the safe flow of all air traffic. UAS comply with the ACO, ATO, and SPINS just as manned systems do. Commanders, in coordination with their A2C2 element, should consider UAS airspace requirements as early as possible in the planning process of any UAS mission and submit the request for approval with equal urgency. Commanders must then continuously monitor, update, and refine airspace coordination during mission execution. Although UAS frequently operate from tactical field locations, constant communications with the airspace agencies in theater is required. See FM 3-52 and JP 3-52 for complete A2C2 information.

4-96. The UAS commander must ensure his A2C2 representative deconflicts airspace. The designated soldier must be very familiar with the ground commander's plan. This familiarity will enable the soldier to make appropriate initial and contingency A2C2 recommendations when dynamically retasking the UAS. Because of the workload required for the initial requests process and then refining the coordinated airspace as the battle progresses, the supported commander must permit the designee to work solely on A2C2 issues.

4-97. Deliberate or preplanned UAS operations should be included in the ATO, special instructions (SPINS) or airspace control order (ACO). The UAS unit will do the planning. The minimum information required is—

- ROA/ROZ.
- Altitudes.
- Ingress route (azimuth, distance, time).
- Egress route (azimuth, distance, time).

- Entry control points.
- Holding points.
- Emergency recovery point (including route).
- Control point location.

4-98. Hasty UAS operations involve a need for immediate UAS coverage in an area not previously planned. This may require a shift from an ongoing mission to a new location. The need for this mission will require immediate coordination for the appropriate airspace. The supported unit must coordinate airspace before UAS movement in support of the new mission. The minimum information required is—

- Call sign.
- Time of launch/duration of mission.
- Shape (circle, box, track) and location of the UAS ROZ/ROA.
- Launch and landing coordinates.
- Required altitude.

4-99. UAS missions should be coordinated with the ACA, AADC, and JFACC to separate UA safely from manned aircraft and to prevent engagement by friendly AD systems (FM 3-100.2). For Raven missions below the coordinating altitude, the divisions or BCTs are the approval authority and airspace coordination and deconfliction is handled by the BAE. See appendix B of this manual for detailed planning information for Raven operations.

4-100. The ACA may establish specific UA flight routes and altitudes and publish them in the airspace control plan. UAS missions may be either preplanned or hasty in nature. Preplanned UA flights should be included in the ATO, SPINS, or ACO. Hasty UAS missions will be coordinated with the appropriate airspace control agencies to ensure the safe separation of UA from manned aircraft and to prevent inadvertent engagement by friendly AD elements.

4-101. Some UAS are equipped with ultra high frequency (UHF)/very high frequency (VHF) radio communications and can be deconflicted like other airspace users. For UAS not equipped with direct communication between the UAS mission crew and other airspace users, procedural ACMs are a necessary part of operations. UAS missions, changes in L/R site locations, UA altitudes, operating areas, IFF squawks, and check-in frequencies are reflected in the daily ATO, ACO, or SPINS and disseminated to appropriate aviation and ground units or agencies.

4-102. The A2C2 designee presents an initial UAS A2C2 plan the UAS commander can take to wargaming. Planners may employ ROZs, routes, and a blanket altitude request as part of the airspace plan. The A2C2 plan is developed upon receipt of a WARNO. The wargaming process will then refine the A2C2 plan based upon envisioned enemy actions, the use of CAS, artillery locations and targets, potential dynamic retasking of the UAS, and integration of Army aviation. Wargaming is the time when airspace users should synchronize activities. Having an initial plan before wargaming improves synchronization and speeds modification and finalization of the A2C2 plan.

4-103. Planners monitor UAS airspace usage during the fight to ensure it does not conflict with current operations. Changes in allocation of CAS, artillery, Army aviation, and the dynamic retasking of UAS will cause conflicts in airspace use. To address these changes, the supported unit should have a periodic A2C2 meeting with all the key players (BAE, ECOORD, S3 Air [if assigned], air liaison officer [ALO], and others) to address these issues. Actions resulting from the meeting may include redirecting the UAS to a different preplanned ROZ or adjusting its current ROZ. Another technique is to address these issues during the targeting meeting. Whether formal or informal, presence of key airspace players is necessary for this meeting.

SECTION V—COMMAND AND CONTROL

4-104. An important aspect of UAS operations is the ability of officers and senior NCOs of the battle staff to focus UAS to accomplish assigned missions. This means close integration of the UAS operator with operations staff and intelligence analysts to find and verify CCIR and to conduct the corresponding analysis. Communications between the TOC battle staff and UAS MC must be open and frequent. This is critical during fire missions and other times when immediate feedback from the UAS is necessary. Reliable communication and coordination facilitate the UAS MC's ability to relay flight instructions to the UAS operator at the GCS/GCU. By working closely together, both parties can ensure maximum effective utilization of the UAS to accomplish the mission successfully.

4-105. The GCS controls the UA during flight. After the EP launches the aircraft and it has climbed to an en route altitude, the EP transfers control of the UA to the aerial VO inside the GCS. The VO controls the UA via the C-band microwave data link from inside the GCS shelter. The data link must maintain LOS between the UA and the GCS. The GCS can also be located several kilometers away from the company TOC. Communications between the GCS and TOC is by MIRC, landline, or radio as provided by the supported unit. Reliable secret internet protocol router (SIPR) net access is required before flight.

4-106. For a UAS to support operation in real time or near real time, information must flow rapidly in two directions. The location of the GCS within the TOC ensures maximum use of system capabilities. In all digital TOCs, commanders and staff can view the UAS digital picture on a screen in the briefing area of the command information center (CIC). This allows the commander to rapidly focus combat power in response to located enemy actions/positions. When collocated with an all-source analysis system (ASAS) remote workstation (RWS), the GCS allows the MI analyst at the RWS terminal to capture an image identified by the UAS operator on his screen, conduct a screen print, and carry out further detailed analysis of the image. When located next to the Advanced Field Artillery Tactical Data System (AFATDS), the GCS supports the fires cell and the crew using UAS data to execute calls for fire.

4-107. In addition to the considerations above, Raven teams are best employed when properly staffed with an UA operator, MC, and radio telephone operator (RTO) and supervised by an NCO or junior officer. An OIC or NCOIC can obtain the required resources for the team (that is, vehicles, radios, supplies), interfaces more effectively with the higher headquarters staff, and provides supervision to the team. Without a clear, established unit POC for Raven operations, the Raven team will be disorganized and incapable of rapid response to time sensitive missions.

LEVELS OF INTEROPERABILITY

4-108. The flexible nature of UAS offers commanders and staffs a wide range of options to integrate UAS capabilities into the operations plan and to fulfill collection requirements. UAS interoperability and employment options are companion considerations in the development of UAS C2, payload employment strategy, and the operation/collection plan

4-109. Army units will incorporate the defined levels of interoperability within the current hardware/software, until hardware and software is available to fully maximize and integrate these levels. Familiarity and application of the levels of interoperability into current operations will prepare units to integrate the future fielding of an Army approved hardware/software system. The levels of interoperability are identified below.

LEVEL I - RECEIPT AND DISPLAY OF SECONDARY IMAGERY OR DATA

4-110. Level I interoperability involves receipt and display of UAS-derived imagery or data (RVT or ROVER) without direct interaction with the UAS. Personnel complete reception of imagery and data through established communications channels. Level I requires a minimum connectivity with JBS/GBS, CGS, or ABCS.

LEVEL II - RECEIPT OF IMAGERY OR DATA DIRECTLY FROM THE UNMANNED AIRCRAFT

4-111. Level II interoperability involves receipt and display of imagery and data directly from the UA without filtering or processing. This requires a RVT or ROVER to interact with the UA beyond that required for Level I operations. At a minimum, Level II operations require an UA-specific data link and a compatible LOS antenna to receive imagery and telemetry direct from the UA. Because Level II operations involve direct interaction with the UAS, RVT operator training is required.

LEVEL III - CONTROL OF THE UNMANNED AIRCRAFT PAYLOAD

4-112. Level III interoperability involves control of the payload separate from control of the UA. In Level III operations, the payload is controlled from somewhere other than the GCS (possibly a secondary GCS). The TOC initiates directed instruction on the payload operation via radio, landline, or other communication methods. For example, the control station is 300 meters from the TOC and a secure telephone unit (STU)-III is in the control station for communication between the TOC and MPO. Level III interoperability requires commander and staff training on UAS operations, and UAS operators qualified and current in payload control operations.

LEVEL IV - CONTROL OF THE UNMANNED AIRCRAFT, LESS TAKEOFF AND LANDING

4-113. Level IV interoperability involves control of the UA and its payload. Level IV operations have the same hardware requirements as Level III. Level IV operations require additional commander and staff familiarization training on flight characteristics of the UA in use. UA operators must be trained, qualified, proficient, and current in the operating service's training and operations regulations for the UA.

LEVEL V - FULL FUNCTION AND CONTROL OF THE UNMANNED AIRCRAFT TO INCLUDE TAKEOFF AND LANDING

4-114. Level V interoperability involves full function and control of the UA to include takeoff and landing. Level V operations have the same hardware requirements as Levels II to IV plus any unique launch and recovery equipment with the added requirement for automated takeoff and landing capability. The automated system may be a system such as the UAS Common Automated Recovery System, a microwave-based system, or through a differential GPS system such as the Integrity Beacon Landing System. Level V operations require appropriate operator training in flight operations for specific UA. UA operators must be trained, qualified, proficient, and current in the operating service's training and operations regulations for the UA.

4-115. Level V interoperability is not a selectable option because hardware/software necessary to implement this option currently is not available.

FUNCTIONALITY

4-116. Each higher level incorporates the functionality of all lower levels. For example, Level V, in addition to UA launch and recovery, also provides the operator full capability to control the UA in flight, control payload operations, receive UA payload products directly from the UA, and disseminate those products to other compatible hardware/software equipped units (table 4-5).

Table 4-5. UAS control options

UAS	Multiple GCS	Handover between like units	UA control with moving GCS	RVTs per system	UA to RVT reception range	Level of interoperability
I-Gnat	No	No	No	None	N/A	2
Hunter	3 *	Yes	No	4	40 km	4 **
Shadow	3 *	Yes	No	4	50 km	4 **
Raven	No	Yes	Yes	1	10 km	2
* Two GCSs and one launch and recovery station (LRS) (Hunter)/PGCS (Shadow).						
** Based on collocation of GCS with organic/supported unit TOC.						

COMMUNICATIONS

GENERAL

4-117. UAS use fiber-optic cabling and unshielded twisted pair local area network (LAN) cable for internal system ground communications, Single Channel Ground Airborne Radio System (SINCGARS), and mobile subscriber equipment (MSE) for external communications on the battlefield. UAS communications nets depend on the UAS, echelon of employment, and operation they support. They use standard DOD communications security (COMSEC) equipment and procedures.

4-118. Video communications can come directly from the UAS or as a secondary product from the receiving control station. Decisions regarding the method of passing the video must consider quality required, distances to cover, availability and priority of communications assets, and capabilities and locations of transmitter and receiver systems. Video options may include, but are not limited to, the following:

- Microwave.
- RVT (must remain within UA distance parameters).
- T-1 line.
- SIPR/nonsecure internet protocol router LAN lines (high band width).
- Cable from second UAS control station.
- SATCOM (for example, GBS).

4-119. Audio communications typically are independent of the UAS, but, in some cases when appropriately equipped, relay using the UAS is acceptable. Audio options may include, but are not limited to, the following:

- Military frequency modulation channel radio.
- VHF or UHF radio.
- HF radio.
- SATCOM.
- Voice over internet protocol.
- SIPR chat room.
- Satellite phones.
- Land line phone.
- Secure cell phone.
- Microwave.

COMMUNICATION FREQUENCY MANAGEMENT

4-120. The electronic tether between the GCS/GCU and UA is susceptible to interference and jamming. The main problem in nearly all cases comes from friendly units. Low-power transmitters in the UAS frequency range cause minor difficulties, but high-power transmitters cause problems, especially when located in close proximity to a GCS/GCU. The unit signal officer and staff can eliminate this problem by providing a sufficient buffer between frequencies and appropriate distances between transceivers.

4-121. Frequency management will become more difficult when each maneuver brigade has its own UAS. UAS supported units from different corps, divisions, and brigades will share common boundaries, fly the same type of UA, and operate them simultaneously. Radio waves, however, do not adhere to unit boundaries. Without proper management, one brigade's GCS/GCU could send commands to an adjacent unit's UA that could receive and execute the electronic order. Tangled video downlinks from different UA can send imagery from the first brigade's aerial sensor to an RVT in the second brigade's sector causing serious confusion. Corps and division frequency managers need to coordinate and synchronize all UAS-related transmissions. Because of the limited number of frequencies and transmission ranges, managers may have to do this on an hourly basis.

USING A REMOTE VIDEO TERMINAL

4-122. Using a RVT in the field can be challenging. RVTs typically receive the video signal directly from the UA, and their display may not have an overlay of aircraft and sensor data as provided by signal processors at the GCS. As a result, the RVT user can find it hard to tell where the sensor is looking and from what direction it is looking. Compounding the problem, the user may be distracted from the video, and an orbiting UA causes a constantly changing orientation of the image. Someone who is not familiar with the terrain in the area of interest will likely have to talk to the GCS to get a geographical orientation (for example, "North is to the left of the screen.").

TERMINOLOGY

4-123. A controller (such as the joint terminal attack controller (JTAC) or UAS MC) working with the GCS to obtain video of a target area can direct both the UA and its sensor. A request to the GCS, such as "reposition to the north end of the airfield," leaves it unclear to the UAS flight crew whether to move the sensor or UA. Table 4-6 lists some suggested terms to help standardize communication with the GCS. While these terms are common in some units, they have not received formal approval for use in multi-service or joint operations. Controllers and UAS crews need to make an extra effort to ensure a correct understanding of all instructions.

Table 4-6. Suggested terminology for UAS control

Term	Meaning
Zoom (in/out)	Change the sensor's FOV
Switch polarity	Change the IR camera from white hot to black hot or vice versa
Capture	The object of interest has been located and is being tracked
Terms to change the sensor point of interest (POI), leave the UA flight path unchanged	
Pan (left/right/up/down)	Move the sensor as indicated relative to the current image
Slew (to position)	Move the sensor POI to the indicated position
Reverse (to object)	Reverse the panning direction to an object previously seen
Monitor (object)	Keep the indicated object in the sensor's FOV
Terms to change the UA flight path, leave the sensor POI unchanged	
Move (to location)	Reposition the UA to the indicated location

Table 4-6. Suggested terminology for UAS control

<i>Term</i>	<i>Meaning</i>
<i>Terms to change both the UA flight path and the sensor POI</i>	
Look (at location)	Reposition the UA and sensor as necessary to provide coverage of the indicated location
Track (object)	Reposition the UA and sensor as necessary to keep the indicated object in the sensor's FOV

4-124. When asking the payload operator to pan the sensor, giving a distance as well as a direction is often helpful. Simply asking the operator to stop panning may result in overshooting an object of interest, particularly if the satellite relay causes a delay in the request. Usually, the operator judges distance by looking at the scale indicator on the display screen. If the system lacks such an indicator, giving the distance in terms of screen widths is often effective.

SECTION VI—RISK MITIGATION

SAFETY

4-125. An effective safety program for UAS operations is a basic requirement in all units. Everyone must be immediately recognize and correct potentially dangerous situations. UA accidents can result in more losses than from enemy action unless the unit adheres to their safety program.

ACCIDENT CAUSES

4-126. A single factor such as human error or materiel failure seldom is the only cause of an aviation accident. Accidents are more likely to result from a series of contributing factors. The following areas require constant command attention to prevent aviation accidents:

- Human factors.
- Training, education, and promotion.
- Equipment design, adequacy, and supply.
- Normal and emergency procedures.
- Maintenance.
- Facilities and services.
- Natural and operational environments.

4-127. Commanders must ensure their personnel learn from errors generated in their own units. Flightfax and other publications provide additional examples and information. All personnel must strictly adhere to published procedures and apply risk management at all levels of operations.

SAFETY INFORMATION

4-128. The United States Army Combat Readiness Center (USACRC) (formerly the United States Army Safety Center), located at Fort Rucker, Alabama, maintains the Army's main store of safety information, guidance, publications, policies, commentary, and suggestions for commanders and unit members at all levels. The Center can assist the unit in conducting the following items:

- Safely perform combat missions and train using risk management.
- Promptly report and thoroughly investigate accidents.

- Review command accident performance (individual events and trends).
- Improve risk management skills through resident and on-line training courses and the study of lessons learned.

4-129. USACRC information is located at <https://safety.army.mil>. UAS personnel at all levels are highly encouraged to thoroughly explore and become familiar with all features of the website.

SAFETY REGULATIONS

4-130. Personnel should review the following safety publications:

- AR 385-10 regulates overall safety.
- AR 385-40 is the accident reporting and investigation guidance.
- AR 385-95 regulates the Army Aviation Accident Prevention Program.
- Department of the Army Pamphlet (DA Pam) 385-40 covers accident investigation and reporting.
- Your command and local safety regulations and policies that cover unit specific operations.
- Not specifically safety regulations, the following contain important information that directly affects safety:
 - AR 95-1.
 - AR 95-2.
 - AR 95-23.

RISK MANAGEMENT

4-131. Tough, realistic training conducted to standard is the cornerstone of Army warfighting skills (see appendix C). Realistic, intense training that stresses Soldiers and equipment proficiency does not have to increase the risk of serious accidents. A unit that implements an effective risk management strategy as an integral part of their training program effectively enhances combat potential. An accidental loss in war is no different from a combat loss in its effects; the asset is gone. Commanders and staffs can use the following discussion as a guide for managing risk as it applies to their organization and mission. The basis for the accompanying guidance is FM 3-100.12, FM 5-0, FM 6-0, and FM 100-14.

4-132. Risk management is a tool leaders can use to reduce risk. It enables leaders to execute realistic training scenarios while concentrating on mitigating factors known to have a high probability of causing accidents. It is a common sense method of identifying areas that present the highest risk and taking action to eliminate, reduce, or control the risk. Risk management therefore becomes a fully integrated part of mission planning and execution.

COMMANDER

4-133. Unit commanders are responsible for conducting all unit activities according to established safety rules and regulations. Risk management procedures are used to assess risks to the mission, develop and implement controls, and supervise implementation of controls. The commander is ultimately responsible for effectively managing risk. He must—

- Willingly determine the proper balance that achieves optimum, not just adequate, performance from their command.
- Select the best risk-reduction options provided by the staff.
- Accept or reject residual risk based on perceived benefits.
- Train and motivate leaders, at all levels, in the effective use of risk management concepts.

PLATOON LEADERS

4-134. Platoon leaders review control measures for feasibility. They report risk issues beyond their control or authority to their seniors for resolution. Platoon leaders recommend changes to improve synchronization of their operations in support of the higher commander's plan. They use the risk management process to identify, assess, and control hazards for their mission.

UNMANNED AIRCRAFT SYSTEM OPERATIONS OFFICER

4-135. The UAS operations officer (150U), as an aviation safety officer (SO) and advisor to the commander, ensures integration of risk management in all aspects of planning, directing, coordinating, and controlling to support force protection. In the risk management process, each UAS operations officer must—

- Recommend appropriate control measures.
- Use risk management to assess his functional area.
- Recommend appropriate control measures to reduce or eliminate risk.
- Integrate selected risk control into plans and orders.
- Recommend elimination of unnecessary safety restrictions that diminish training effectiveness.

4-136. All personnel must be aware of the safety rules established for individual and collective protection. Each person is responsible for reading and following unit SOPs, instructions, checklists, and other safety-related information. They must report safety voids, hazards, and unsafe or incomplete procedures. Each Soldier must follow through until correction of the problem.

UNMANNED AIRCRAFT SYSTEM SAFETY CONSIDERATIONS

FIGHTER MANAGEMENT

4-137. Commanders must ensure their personnel are adequately rested to perform flight operations. The safety officer is charged with tracking duty hours for personnel on a daily, weekly, and monthly basis or as required by unit SOP. When able, the safety officer should also ensure that night and day shift personnel have separate sleeping quarters to ensure proper rest.

WEATHER

4-138. Commanders must weigh mission importance and possibility of launch success when weather is out of tolerance. Mission commanders should continue to monitor weather conditions after launch. Changing weather could degrade flight performance, onboard sensors, or decrease mission endurance time.

4-139. Commanders and safety officers must also account for and formulate controls for the effect of extreme weather on personnel and ground equipment. For example, hot environments can produce heat casualties and cause GCUs to overheat.

TERRAIN

4-140. UAS are limited by LOS for operator control. Carefully planning involving all available resources is important for determining LOS limits. This is especially important for low flying systems like Raven. When a possible LOS problem exists, units may consider transferring control in flight to a different GCS. Leaders should also ensure that UA are properly programmed with home waypoint in case of loss of link.

LAUNCH/RECOVERY OPERATIONS

4-141. The safety of Soldiers working in or around the L/R site is the single largest concern. Nonessential personnel should maintain a safe distance (minimum of 50 meters) from the L/R area. Units should practice takeoff, landing, and emergency operations on the mission simulator on a regular basis. Commanders, platoon leaders and NCOs should ensure operators follow specified training and checklists. In addition, leaders should ensure checklists are correct and are the most current available. For Raven, the site selection itself is of the utmost importance when conducting launch/recovery operations.

MAINTENANCE

4-142. As with launch/recovery operations, leaders should ensure maintenance personnel adhere to appropriate technical manuals and unit SOPs when working on the UA. Leaders must stress the importance of proper preflights and postflights.

Chapter 5

Unmanned Aircraft System Employment

UAS operations support battlefield commanders and their staffs as they plan, coordinate, and execute combat operations. UAS increase the SA of the commanders during R&S missions. Army UAS can perform some or all of the following missions: enhanced targeting through acquisition, detection, designation, and BDA. In the future, specially configured UAS may assist communications through relay of digital communications and extension of the Force XXI battle command brigade and below (FBCB2) network. UAS may also support mine detection, weather, and CBRN reconnaissance to facilitate friendly mobility. They create opportunities to employ lethal and electronic warfare (EW) means, enabling friendly force operations and degrading those of the enemy. Other UAS missions support the maneuver commander by contributing to the increased effectiveness of smaller unit tactical operations. GCSs with common data links, RVTs, PGCSs, and the teaming of UAS with Army helicopter/A2C2S will enhance SA/situational understanding (SU) by feeding the COP, thus helping to set the conditions for the current and FF's success.

SECTION I—RECONNAISSANCE AND SURVEILLANCE

RECONNAISSANCE

5-1. UAS reconnaissance missions obtain information about activities and resources of an enemy or potential enemy, or secure data concerning meteorological, hydrographic, or geographic characteristics of a particular area. A nonlinear, expanded battlefield will routinely create gaps between friendly units. Reconnaissance of these gaps is an excellent mission for the UAS. UAS units perform reconnaissance before, during, and after combat operations and provide the combat information to applicable tactical leaders and users, who in turn pass it along as SA for higher and adjacent echelons and combatants.

5-2. The tactical commander's ability to seize or retain the initiative and concentrate overwhelming combat power at the right time and place depends on having current and relevant threat information, such as—

- Location.
- Activity.
- Size.
- Composition.
- Direction of movement.
- Rate of advance.

5-3. UAS provide the information needed for the supported commander to concentrate combat power through maneuver. They also provide information on which routes and cross-country terrain best suit maneuver to allow for decisive engagement of the enemy.

5-4. Information derived from UAS assets facilitates maneuver by helping the supported unit determine suitable terrain and detect possible threats that may influence that terrain. Units supported by UAS assets

may take the information generated by UAS units and immediately send spot reports to organizations that need combat information. RVTs in or near TOCs also permit direct access to near real-time UAS imagery during reconnaissance.

5-5. Manned attack reconnaissance aircraft and multiple levels of UAS are part of a larger reconnaissance effort that occurs jointly and within the Army from corps down to squad level.

5-6. The four forms of reconnaissance are route, zone, area, and reconnaissance in force. In most mission profiles, integration of ground and air reconnaissance provides mutual reinforcement. For example, ground units may reinforce air units if the terrain offers concealment from aerial observation. UAS augment ground reconnaissance efforts from as close as seeing over the next hill or around the next block to as far as hundreds of kilometers away, corresponding with the supported commander's battlespace. Discussion of manned, unmanned (MUM) teaming is found throughout this chapter. All references to MUM team control are taken from the approved five UAS levels of interoperability. For an explanation of the UAS levels of interoperability, refer to chapter 4.

UNMANNED AIRCRAFT SYSTEM RECONNAISSANCE FUNDAMENTALS

5-7. UAS conduct reconnaissance according to the following seven fundamentals:

- **Gain and Maintain Enemy Contact.** Commanders dictate the desired degree of contact before commencing the mission. Once reconnaissance units, including UAS, make contact, they retain contact until relieved or given the order to break contact. UAS report information immediately and continuously updates the commander on the tactical situation. UAS maintain visual contact from a distance; attack the target if armed, or handover the engagement to armed UAS, attack reconnaissance helicopters, or indirect fires. UAS at multiple echelons permit maneuver units to retain freedom to maneuver while maintaining contact.
- **Orient on the Objective.** Reconnaissance elements orient on the location or movement of the reconnaissance objective. The objective may be a terrain feature, a locality, or an enemy force. Manned air reconnaissance orients on the objective and positions itself to retain freedom of maneuver at terrain flight altitudes. UAS reconnoiter the objective from an elevated perspective. Depending on sensor type and sensor field of view, zoom capability, slant angle, and level of resolution, UAS create an imagery "map perspective" of the reconnaissance objective/routes with varying scale and detail without endangering lives.
- **Report Rapidly and Accurately.** Reconnaissance elements report all information rapidly and accurately. Information that initially appears unimportant may become valuable when combined with other information. Knowing an enemy force is not in one location can be just as important as knowing it is in another. For information to be useful, reconnaissance elements must report in a timely manner. Future UAS will permit RETRANS of voice, digital data, and imagery to facilitate reconnaissance reporting. Combat elements require access to imagery, sensor data, and automated spot reports from ground and air, and manned and unmanned systems and sensors. MPCSS and (or) GCSs distribute information, or data/imagery goes directly to portable display systems and CGSs and eventually to manned ground and air combat systems.
- **Retain Freedom to Maneuver.** UAS obtain information and survive through stealth. Suppressive fires, cunning, and constant awareness of the tactical situation help UAS retain freedom to maneuver. UAS provide information that facilitates reconnaissance teams maneuvering their elements while avoiding decisive engagement. UAS, at multiple echelons, must be controllable on the move and able to transmit data, reports, and imagery to moving combat reconnaissance units and systems.
- **Develop the Situation Rapidly.** UAS develop the situation on the basis of operations order, unit SOP, or the commander's intent. UAS maintain contact, as man-in-the-loop operators, in

GCSs and air and ground combat vehicles reporting contact, executing fires, and conducting other maneuvers as appropriate.

- **Ensure Maximum Reconnaissance Forces Forward.** Air, ground, and UAS reconnaissance is most valuable when providing essential battlefield information. Commanders employ the optimal number of intelligence-gathering manned and unmanned assets in the reconnaissance effort. UAS operate as far forward as METT-TC, endurance, and data link factors allow. UAS integration well forward safeguards and cues the manned ground, air reconnaissance, and security force as well as the main body.
- **Ensure Continuous Reconnaissance.** Effective reconnaissance is continuous and conducted before, during, and after all operations. Before an operation, aerial reconnaissance focuses on filling gaps in information about the enemy and the terrain. During an operation, the UAS focuses on providing updated information that verifies the enemy's composition, dispositions, and intentions as the battle progresses. After an operation, the UAS focuses on maintaining contact with the enemy to determine its next move and collecting information necessary for planning subsequent operations.

RECONNAISSANCE METHODS

5-8. The methods of reconnaissance UAS employ vary. Ground-directed UAS reconnaissance controlled by GCS focuses on shaping and tracking ongoing decisive operations. UAS reconnaissance controlled at brigade and below level, by ground combat elements and GCS, will tend to provide detailed reconnaissance of smaller sectors consistent with that echelon's battlespace and the type of sensor deployed. Maneuver units may use any method or combination of methods necessary to accomplish the mission.

RECONNAISSANCE PRINCIPLES

5-9. When conducting UAS reconnaissance forward of ground forces, detailed coordination reduces fratricide potential. UAS reconnaissance may occur well forward, just forward, "over-the-top," or "over-the-shoulder" of friendly ground and air forces. Means of BFT and use of UAS to track friendly versus enemy positions is always a possible reconnaissance mission. Reconnaissance as a prelude to targeting is another mission. Finally, UAS reconnaissance safeguards manned system assets from excessively dangerous missions. UAS units can also expand the area covered by ground and air reconnaissance assets by permitting division of responsibility for reconnoitered areas. UAS reconnaissance principles include—

- Reconnaissance of areas/objectives where terrain or threat hinder ground or manned air reconnaissance.
- Reconnaissance over extended distances, for extended durations, or both.
- Use of UAS to acquire targets or reconnaissance objectives at maximum standoff distance to retain the element of surprise or maintain UA and manned aircraft survivability.
- Use of UAS motion imagery and other sensors to acquire combat information, fuse it into a usable product, and report it to combat elements and key leaders to update SA.

RECONNAISSANCE BY FIRE OR DRAWING FIRE

5-10. When conducting reconnaissance by fire, the intent is to cause the enemy to disclose its presence by moving or returning fire. UA conversely can draw fire by their very presence, thereby revealing enemy locations for targeting or bypass. Ravens in OIF/OEF proved highly successful by using modified propellers to increase the noise signature, and incited enemy forces to reveal themselves while engaging the UA with small arms fire. Disadvantages include destruction of the UA, loss of surprise, exposing the firing element, and the possibility of decisive engagement.

ACTIONS ON THE OBJECTIVE

5-11. UAS reconnaissance, conducted along a planned flight path selected on the basis of considerations such as UA and payload type, is METT-TC dependent. The UAS maintains the flexibility to alter course at any time.

5-12. Actions on the objective commence five minutes before the arrival at the RP.

- The AMC calls “on target” via headset or MIRC upon acquiring the target.
- The DE/UET (data exploiter/UAS exploitation team) starts recording video (when properly equipped) and continues until five minutes after leaving the target (unless directed sooner).
- The AMC calls “off target” upon transitioning to flight to the next RP.
- The DE submits an initial spot report within five minutes of acquiring the target. If there is any evidence of denial/deception, the AMC immediately notifies the air battle manager.
- The DE/UET prepares an exploited still image (when properly equipped) within 10 minutes of acquiring the target.
- If the target contains any of the indicators from the collection support brief, the DE/UET has 45 minutes to prepare/produce an exploited video (when properly equipped). The DE/UET saves the raw video clip as part of the historical database.

5-13. Regardless of the number of targets, personnel follow the same procedures for each RP. During flight between RPs, the MPO maintains SA and searches for targets of opportunity as directed by the AMC. Detection of a target requires a spot report and, upon decision from the AMC, notification to the air battle manager and start of actions on the objective.

5-14. Raven reconnaissance missions are also conducted along a preplanned flight path. Raven operators familiar with their AO may choose to fly the UA manually. NAIs are usually spaced closely together and the UA is considered to be “on target” for a majority of the flight. Techniques for recording/disseminating information include—

- Establishing standard file storage and naming convention.
- Recording mission from start to finish using 8-mm tape.
- Capturing images during mission using FalconView (if available).
- Capturing images and video clips post mission using memory stick.
- Importing files from camera to laptop.
- Editing images and video as required.
- Placing a text box on new image if location information is cropped out.

DATA EXFILTRATION

5-15. Personnel use voice or data messages to detail observed activity, and send reports reproduced in the GCS to the operations and intelligence (O&I) section or other consumers as directed. The report flow will be maintained through normal intelligence reporting channels and will be created in spot report format (unless otherwise directed). This format facilitates correlation and dissemination of tactical reconnaissance/motion imagery analysts at the O&I at company, and higher echelons perform detailed analysis of UAS products as needed.

VIDEO AND IMAGES

5-16. Using software and hardware available, tactical reconnaissance/motion imagery analysts, as DEs or the UET, create text, imagery, and video products. The DE is responsible for NRT reporting, and the UET provides secondary and postmission analysis. MOSs 15W performs duty as DEs; other MI MOS (based on availability and payload) can be UETs if trained by the unit.

SECONDARY IMAGERY DISSEMINATION

5-17. The baseline standard for secondary imagery dissemination (SID) is annotated imagery. In time critical situations, imagery not annotated is acceptable. An example SID is below (figure 5-1).



Figure 5-1. SID

5-18. During surveillance missions, poststrike assessment, or lethal payload operations during direct support taskings, the tactical reconnaissance/motion imagery analysts provide an enhanced product that combines annotated imagery, digital mapping, and text reports. An example (using the threat overlay and 5 meters controlled image base from PFPS/FalconView) is depicted in figure 5-1.

5-19. If no digital transport is available, VO/MPOs print hard copies of each target and annotate text reports on attached paper. AMCs ensure transport of video media installed for all support missions directly to the O&I section.

SURVEILLANCE

5-20. The Army's larger UAS are well suited for surveillance missions because of their ability to stay airborne for extended periods. This enables continuous surveillance of avenues of approach (NAIs, TAIs, DPs, and other areas) deemed critical by the commander. At lower echelons, the term "staring" often accompanies the role of UAS surveillance, indicating a persistent observation of a particular area.

5-21. The threat can attack throughout the depth and breadth of the battlefield. When the battlespace is linear, commanders may employ UAS assets to perform dedicated surveillance of rear areas. This UAS support may supplement the capabilities of other rear area units/assets or relieve combat units of contingency missions that may detract from their primary mission. In a more nonlinear environment, UAS surveillance of base camps, airfields, and key logistic sites in lesser-contested areas may free combat forces to perform other missions and help prevent surprise.

5-22. Units can conduct surveillance missions as a subset of reconnaissance and (or) security missions. If during reconnaissance a UAS unit locates enemy elements, it may continue to perform surveillance and maintain contact with the enemy element, if so directed. Likewise, security missions may require UAS surveillance that facilitates development of the situation once contact occurs.

SECTION II—SECURITY OPERATIONS

5-23. Conducting security operations—

- Provide early and accurate warning of enemy operations.
- Provide the protected force with time and maneuver space to react to the enemy.
- Develop the situation, allowing the commander to use the protected force effectively.

5-24. The distance the reconnaissance element operates from the supported unit is a function of METT-TC and UA endurance, but generally it is forward enough to provide the ground commander early warning to maneuver before enemy engagement. SBCT doctrine identifies “multi-dimensional” as a type of reconnaissance. See ST 2-19.602/3-20.972.

5-25. A commander thinks and plans in terms of the time and space required, maneuvering and concentrating subordinate units against enemy weaknesses. Reconnoitering or performing security operations well forward or to the flanks of the main body, security elements develop the situation and prevent the commander from fighting at a disadvantage. The UAS assist security elements in providing time for the commander to assess the situation, determine a course of action (COA), issue orders, and maneuver. Security elements assisted by UAS also provide space to maneuver, creating flexibility for the commander to respond to unanticipated enemy initiatives. The commander’s intent determines the buffer size in terms of time and space. The assigned screen, guard, cover, or area security mission further defines buffer size.

5-26. Corps and division may receive direct access UAS imagery products and radar data to assist the advance guard or covering force. Maneuver unit security elements also have UAS access to assist the security mission.

5-27. Sustainment and preservation of combat power are critical to combat effectiveness. Winning the current battle is only part of the fight. Security elements protect and preserve combat power until the commander determines where to concentrate forces so they can maneuver into engagements with the enemy. During offensive operations, security elements with UAS prevent premature deployment and attrition of friendly combat power before reaching the objective. In defensive or retrograde operations, security elements with UAS provide early warning of enemy approach, destroy or repel enemy reconnaissance elements, force the enemy to assume its attack formation prematurely, and fight enemy lead elements as required. If required, the security element with the UAS protects the main body from engagement, so the commander does not have to divert forces from his main effort.

5-28. The types of security missions are screen, guard, cover, and area security.

SCREEN

5-29. The primary purpose of a screen is to provide early warning to the main body. Screen missions are defensive in nature, largely accomplished by establishing a series of OPs and conducting patrols to ensure adequate surveillance of the assigned sector. A screen provides the protected force with the least protection of any security mission. On the basis of the higher commander’s intent and the screen’s capabilities, security elements destroy enemy reconnaissance and may receive a tasking to impede and harass the enemy main body with indirect or direct fires. The UAS and MUM teams are ideally suited for screen missions.

CRITICAL TASKS

5-30. Critical tasks of the UAS, include the following:

- Provide early warning of enemy approach. UAS and MUM teams operating forward or looking forward with sensors are often able to detect enemy approach before other tactical ISR assets.
- Maintain continuous surveillance on all battalion-sized avenues of approach into the sector (protected division in major theater war). From positions determined by the IPB, UAS and MUM teams can prevent large enemy units from surprising the main body.
- Gain and maintain enemy contact. After making contact, UAS are ideal to maintain contact while ground scouts and manned air reconnaissance assets reconnoiter elsewhere, maneuver to a vantage point that avoids decisive engagement, or resupply at a forward arming and refuel point (FARP).
- Report enemy activity. UAS report acquired enemy activity by spot report.
- Destroy, repel, or suppress enemy reconnaissance units (within capabilities) without decisive engagement. UAS target designation capabilities enable cooperative destruction of enemy scouts by manned aircraft and armed UAS.
- Impede and harass the enemy with indirect fires. Precision UAS sensors with integrated grid coordinate displays or terrain association of what the UAS views provide manned aircrews, ground scouts, and FECs with access to UAS imagery to employ on-call and preplanned fires.
- Guide reaction forces. Personnel use the UAS combat information to assist main body elements in moving forward to optimum locations and engage the enemy.

SCREEN CAPABILITIES

5-31. The UAS' superior mobility, day and night TA capabilities, long-range digital or voice communication or RETRANS, and video sensors make them ideally suited for screen missions. UAS units may conduct screen operations independently, as part of a MUM team, or as an integral part of a larger ground unit's task organization. Use UAS as an extension of ground surveillance to see-over-the-next hill. UAS and (or) MUM teams may use air assets as a series of OPs with air patrols occurring en route between OPs. The ability of UA to conduct surveillance from an overhead pattern provides a different perspective than manned systems that view the area from a terrain flight altitude. Together, in teams, or in separate sectors, both contribute to early warning for the main body. When participating in guard and cover operations, UAS and (or) MUM teams normally conduct screen or zone reconnaissance as part of a larger force.

TASK ORGANIZATION

5-32. The screening unit task organizes and assigns UAS to occupy the screen and establishes an UA or team rotation to maintain continuous surveillance. If the screening unit requires relief on station or battle handover from another unit, both units coordinate to determine the requirements. MUM teams handover UAS control to relieving manned aircraft teams or a GCS as manned aircraft transition to the FARP.

SCREEN PLANNING

5-33. The nature of the terrain and projected speed of threat forces are critical to determining the size of the UA flight path. UAS participation in a screen mission may permit manned aircraft to remain at one OP while the UAS provides imagery and other sensor data over a larger area. The manned aircraft and UA can also coordinate alternating coverage so they are on opposite ends of the screen line, assuring more thorough, continuous coverage. If two UA are available to screen the same sector, they can fly at opposite ends of the same screen line.

INITIAL SCREEN LINE

5-34. The most secure method of establishing an initial screen line is to conduct a zone reconnaissance to the initial screen line. UAS can assist in zone reconnaissance by reconnoitering routes forward and checking choke points and suspected air defense artillery (ADA) sites. A good rule of thumb is to have UAS fly the initial screen line first. When ground and air maneuver units reach the general trace of the screen line, they reconnoiter and refine it. They also select positions for good observation and fields of fire and good areas for UAS “staring.” UAS and ground and air maneuver units seek to remain undetected while reporting on enemy activity and engaging enemy forces with indirect fires at maximum range. A combination of obstacles and coordinated fires allows the air and ground scouts, and other screening elements, to impede enemy lead elements, maintain contact, and avoid decisive engagement. This gives the main body reaction time and maneuver space to engage the enemy effectively. UAS and ground and air maneuver units may continue reconnaissance forward to identify enemy second echelon and follow-on forces. Upon contact, UAS and ground and air maneuver units may focus their efforts on the destruction of enemy reconnaissance elements by direct and indirect fires before enemy scouts can penetrate the initial screen line.

MOVING SCREEN

5-35. When the main body is moving, the screening force and any supporting UAS conduct a moving screen. The commander determines the technique of screening a moving force based on METT-TC, his own and the higher commander's intent, and the unit's orientation. The commander assigning the screening mission provides the parameters of the screen and the times and locations to establish the screen. He determines which elements lead, lag as a rapid response force, or move adjacent in a parallel sector or along the flank or rear. UAS, alone or with other air assets, are ideal to lead in open terrain where long-range sensors and lack of overhead cover are optimal for manned and unmanned aviation. In denser terrain with cover and concealment, and in urban areas, ground reconnaissance may lead. In that case, UAS can screen the area between the screen force and main body. The commander identifies the unit or units to screen and provides the operations overlay and control measures. The two types of moving screens are flank and rear.

Moving Flank Screen

5-36. The moving flank screen is the most difficult screening mission. Screening elements move on a route parallel to the movement axis of the main body. The commander defines the initial area to screen, subsequent screen lines, and the rear boundary. Ground and air maneuver units occupy a series of OPs on the screen line. Supporting UAS often fly an initial pattern that allows the UAS sensor(s) to view the outer edge of the screen force's flank boundary while manned screening elements move to their initial screen line. The screen force and supporting UAS screen from the lead to the rear combat element of the main body exclusive of the advance guard and rear security forces. The main body and screening unit must maintain contact at all times. When working with ground troops in a moving flank screen mission, UAS are well suited to maintain contact with the main body or perform reconnaissance farther on the flank than ground screening units. If possible, the UAS reconnoiter out to the maximum range of supporting indirect fires. Except for bounding OPs associated with a moving screen, the mission planning and conduct is the same as a stationary screen. While maintaining contact with the main body, the UAS must be aware of the distance of ground units from the main body and warn ground screen elements when they overextend the screen's distance from the main body.

Rear Screen

5-37. Screening the rear of a moving force is essentially the same as screening a stationary force. As the protected main body moves, the rear screen force occupies a series of successive screen lines. Regulated movement is necessary to maintain the time and distance factors desired by the main body commander. As

in the stationary screen, units are assigned sectors and responsibilities. The rear screen unit may move to subsequent screen lines without main body orders as long as it remains within friendly artillery range and can effectively screen the rear. If the rear screen unit makes enemy contact, the unit executes actions on contact the same as a stationary screen. UAS supporting area screening for main supply routes (MSRs) and other rear areas can provide information and integrate into the overall ISR plan of the rear screen unit. Typically, UAS units do not directly support rear screen units owing to a greater need for these assets along the flanks with the advance guard or to safeguard-specific rear areas. The rear screen may be required to divert assets to act as a rapid response force in the event of rear area incursion. UAS performing area security may be dynamically retasked to assist C2 of the rapid response force.

GUARD AND COVER OPERATIONS

5-38. Although guard and cover missions and task organization differ dramatically from a screen, UAS contribute to both by accomplishing tasks similar to those conducted during screen operations.

AREA SECURITY

5-39. Area security includes R&S of designated personnel, airfields, forward operating bases (FOBs), unit convoys, facilities, MSRs, lines of communication (LOC), equipment, and critical points. UAS are ideal for providing continuous surveillance of routes and key sites in rear areas so other ISR assets can operate forward. An area security force operating in a rapid response mode uses UAS reports to neutralize or defeat enemy operations in specified areas.

5-40. Commanders establish area security screens by integrating UAS surveillance, OPs, GSR, and patrols. UAS can modify their flight patterns to fly continuous large circles around noncontiguous perimeters. Using more than one UA in the pattern reduces time between UA passes. Commanders viewing UAS video in the TOC can immediately employ ground forces, aviation or fire support assets to defeat the threat. Ground commanders utilizing RVTs receive NRT information on enemy strength, location and activity.

AIR ASSAULT AIR MOVEMENT SECURITY

5-41. UAS, attack reconnaissance aircraft, or both can provide aerial escort, overwatch fires, route reconnaissance, and security for air assault operations. A detailed, precise, reverse planning sequence based on a careful analysis of the factors of METT-TC will lead to successful execution of the operation. Planning and UAS integration begin with the ground tactical plan and works backwards to the staging plan as indicated in figure 5-2. Reverse planning is imperative as each successive planning step has an impact on the phase preceding it. FM 1-113 contains a more detailed discussion of air assault planning considerations.

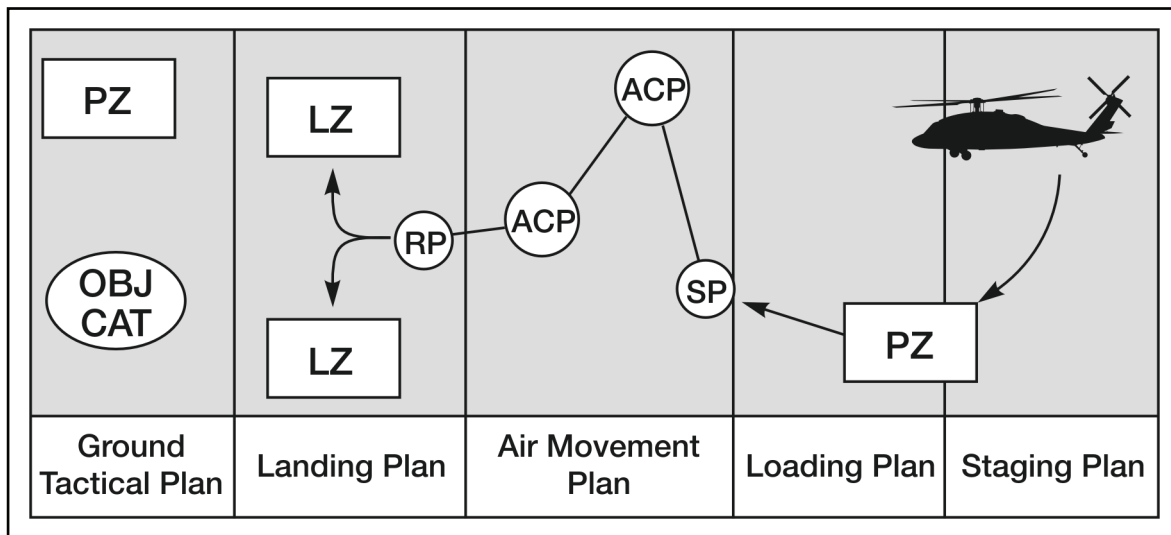

Figure 5-2. Air assault planning stages

Staging Phase

5-42. UAS may conduct screening operations to provide early warning and limited security while friendly troops form on or near pickup zones (PZs). When enemy forces are near or other contact or indirect fire on the PZ is possible, UAS, reinforced with attack helicopters, increase the capability to find and repel enemy forces and silence enemy mortars.

Loading Phase

5-43. UAS reconnoiter PZs beyond the security areas the ground force establishes before assault helicopters arrival. Once aircraft loading commences on the PZ, UAS may fly to the vicinity of the PP to await the first air assault lift or may screen the flanks of the PZ. Ground troops remain in separate AAs with organic security until led to chalk AAs for aircraft loading. The PZ control officer may employ a GCS to gain an overhead perspective of the PZ and arriving and departing aircraft or troops. Ground mechanized or armor companies are also well suited to participate in providing security in both the staging and loading phases. Table 5-1 shows standard PZ markings.

Table 5-1. Marking techniques for day and night PZs

Position in PZ	Daylight Marking	Night Marking
PZ entry	Guide and sign	Guide with 2 blue chemical lights
PZ control	M998 and VS17 panel	2 green chemical lights on antenna
Aid station	M997	Steiner device
Chalk stage points	PZ control party guides/signs	Guide/blue chemical light per chalk
Lead touchdown point	VS17 panel, smoke	Inverted Y, IR flashlight
Chalk touchdown points	Soldier on knees with raised rifle	IR chemical light per aircraft
Obstacles	Notify pilots on radio	Red chemical light ring around obstacle
Loads to be picked up	Hook up team on loads	Swinging IR chemical light per load

Air Movement Phase

5-44. UAS normally precede the air assault lift along the air route. They conduct route reconnaissance followed by area reconnaissance of the LZs, and possibly the objective, depending on the factors of METT-TC. UAS cross the FLOT at lift-sequence dictated time intervals and conduct or assist with an aerial passage of lines in both ingress and egress. Along the route, manned aircraft immediately precede or fly parallel to lift aircraft with UA farther forward. Both manned and unmanned systems try to locate previously unknown pockets of ground fire or enemy AD weapons and radar, and suppress those systems or develop a bypass route for the air assault element. UAS also detect route safety threats to flight, including weather and natural and manmade obstacles. UAS may conduct a moving flank screen for each serial or view planned BPs for manned systems along shorter routes in areas deemed to be potentially dangerous. UAS may have responsibility for coordinating with other task force (TF) elements to facilitate the recovery of downed aircrews.

Landing Phase

5-45. UAS perform similar tasks as the staging and loading phases. UAs fly high above the LZ perimeter looking for approaching threats and focusing on the air assault objective. Following the first lift, a supporting UA may remain at the LZ underground force control while another UA continues with lift aircraft to provide egress and subsequent lift security. UA may fly over false LZs where false insertions occur to deceive the enemy, while simultaneously viewing other locations and potential enemy approaches to the actual LZ. UAS can also assist the TF commander in determining weather alternate LZs are clear when an excessively hot LZ requires an alternate LZ. If employing more than one LZ, UA may fly a pattern between multiple LZs. This permits the rear TOC with a GCS or utility helicopter (UH)-60 A2C2S aircraft with the TF commander aboard to stay apprised of friendly activity.

Ground Tactical Phase

5-46. As the ground force moves forward and seizes its objective, UAS may conduct reconnaissance and screening operations in support of the ground tactical plan. They can reconnoiter the ground route to the objective, as well as the objective itself, from standoff ranges. The armed aircraft can also provide overwatching fires. Thermal tape and other combat identification techniques involving chemical lights and arm signals will aid UAS to differentiate between friendly and enemy forces registering as hot spots in the FLIR. UAS may provide precise grid coordinates for artillery engagement.

SECTION III—UNMANNED AIRCRAFT SYSTEM TARGETING

FACILITATE TARGETING

5-47. UAS facilitate targeting through—

- Target acquisition and assessment.
- Target detection and recognition.
- Laser designation and illumination.
- BDA.

TARGET ACQUISITION

5-48. Target acquisition/assessment is—

- The detection, identification, and location of a target in sufficient detail to permit the effective employment of weapons.
- An examination of potential targets to determine military importance, priority of attack, and weapons required to obtain a desired level of damage or casualties.

5-49. UAS in the course of other roles may perform TA in support of fires and air attack by joint and Army assets. The ability to locate potential targets and provide grid coordinates of target locations assists the fire and effects cell (FEC) in preplanned and on-call fires. UAS-provided grid coordinates assist air interdiction, CAS, and Army aviation maneuvers.

5-50. To make grid coordinates of potential targets more accurate, UAS may laser range find to achieve better accuracy. UAS operators also use a combination of UAS GPS-aided location/altitude and sensor angle/azimuth of view to help determine more exact target locations.

TARGET DETECTION AND RECOGNITION

5-51. Target detection and recognition are typical capabilities of UAVSs given the look down field of view and altitude from which UA typically operate. Therefore, friendly units can expect UAVSs to detect and recognize only suspected targets.

PRECISION OF TARGET LOCATIONS

5-52. Most UAS are able to compute the coordinates of the sensor point of interest (POI) and show them as an overlay on the video display. The precision of these computed coordinates depends on the distance from the UA to the POI and the depression angle of the sensor. When the distances are equal, a small depression angle may result in coordinates less precise than coordinates from a greater angle (figure 5-3). General guidance is the depression angle should be between 60 and 90 degrees for the best precision.

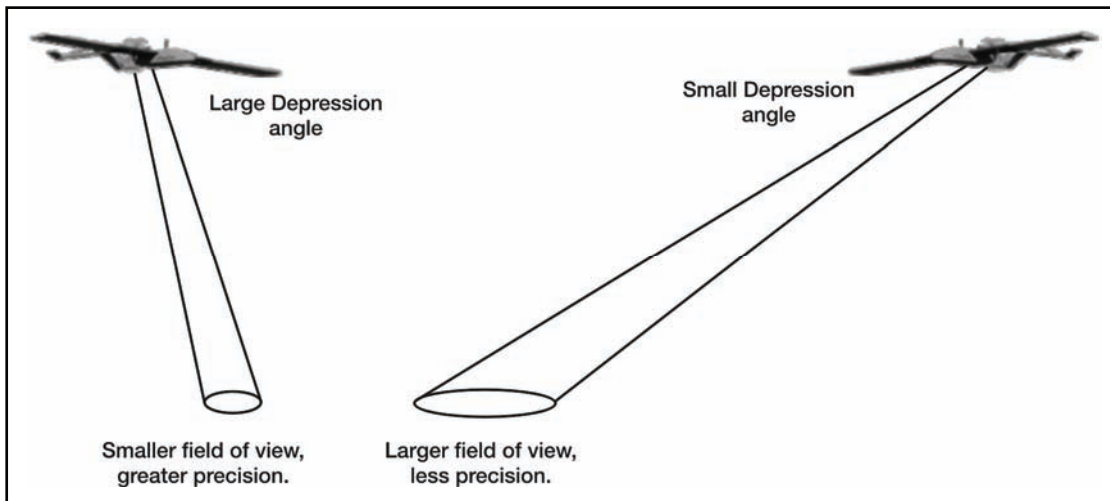

Figure 5-3. Sensor depression angle and location precision

5-53. Even under optimal conditions, a UAS will not be able to produce precisely measured coordinates needed to attack a point target with weapons using a GPS for guidance. Use of supplemental technologies, such as Raindrop, the digital imagery workstation, or digital precision strike suite in conjunction with a UAS image, is necessary to produce measured coordinates.

BATTLE DAMAGE ASSESSMENT

5-54. After engaging the enemy, trained personnel may use UAS imagery to evaluate the extent of damage and necessity for additional engagements. BDA may occur in conjunction with artillery targeting, adjusted using UAS imagery and target location coordinates. FSEs can then observe artillery impact, make immediate adjustment to indirect fires, and determine the necessity for additional fire missions. UAS performing laser designation for laser-guided munitions may also perform BDA after engagement. In both cases, the same UAS assisting the targeting process is available to assist with the BDA.

FACILITATE COMMAND AND CONTROL

5-55. A large battlefield area typically strains communications systems overextended by lost LOS, lack of nodes, jamming, or inadequate range due to friendly force movement and dispersion. Near-future UAS communications relay packages (CRPs) will help maintain communications between commanders and subordinate units. Planned, near-future CRPs will vary in size and waveform depending on UA payload capability on a particular UAS. A small CRP payload may support one voice/data waveform initially, whereas the Joint Tactical Radio System (JTRS) will facilitate relay of up to three waveforms. Requirements exist to relay four or more waveforms on larger CRP payloads. A Hunter UA successfully demonstrated this capability with separate radios, whereas near-future CRPs will accomplish it with a JTRS variant.

FACILITATE MOVEMENT

5-56. Battlefield obstacles, such as mines and persistent chemical contamination, may stop or slow movement or hinder the efficiency of fire and maneuver. Near-future UAS may facilitate movement by conducting standoff detection of enemy surface-laid minefields and areas contaminated with liquid or gaseous chemical agents and their downwind hazards. Weather may also slow or obstruct aerial and ground maneuver owing to limited visibility caused by fog, low cloud ceilings, blowing sand or smoke, and muddy or icy conditions. Currently, UAS may assist in detecting poor weather and other movement inhibitors.

5-57. Positive control of unit movements may require UAS observation of movement. Both past and recent history of maneuver warfare demonstrates movement is the most frequent task a division performs:

- From port of debarkation to AA.
- From AA to attack positions or defensive sectors.
- During repositioning in the defense.
- When conducting a counterattack.
- When repositioning forces for the attack.

5-58. UAS assets may facilitate this task largely by performing R&S. They monitor progress of subordinate elements for the commander. They observe contact points and PPs, and allow staffs to coordinate and deconflict with higher and adjacent units or headquarters.

SECTION IV—MANNED-UNMANNED TEAM OPERATIONS

5-59. The Army is rapidly exploring and evolving the concept of teaming UAS with manned systems. Manned systems may operate from the ground and air. The teaming of UAS with manned systems in NRT brings a synergy to the battlespace allowing each platform (manned and unmanned) to use its combat

systems in the most efficient manner while allowing the teamed asset to supplement its team member's capabilities. In many cases, using unmanned systems in high threat areas will reduce the exposure of manned systems to hostile fire or effects. The Army is quickly learning lessons from combat operations in support of OEF and OIF that will take MUM teaming to the next level. The concept of MUM teaming can be extrapolated to include soldiers in control of direct or indirect fires and effects in CPs with access to NRT UAS imagery. Demonstrated during OIF, this concept employed indirect fires routinely called and adjusted by FS personnel in NRT. The indirect fires resulted in the destruction of targets otherwise missed because of the time required to employ manned systems not already in the area.

MANNED-UNMANNED TEAM MISSIONS

5-60. The most prevalent use of UAS in MUM is in the direct support role to ground forces in tactical operations. UAS routinely provide direct support to ground commanders regardless of the UAS echelon of assignment. Commanders in the TOC who have UAS video feed and a direct common link to UA operators can direct their units against the enemy in NRT. Units in the field can use the RVT to gain enhanced SA/SU during operations. Emerging use of voice over wire ensures troops using RVTs can communicate directly with the UA operator.

5-61. The RQ-11 Raven is a dedicated battalion asset that provides the ground commander with a powerful forced multiplier when properly employed. During close combat operations the Raven provides the commander with NRT information on enemy position and movements. In open terrain Raven can provide “over the hill” intelligence. In urban terrain, locations of enemy on rooftops, alleyways and adjacent streets can be quickly gathered. In addition to maneuvering his forces against the enemy, the commander can also call for artillery fire, attack aviation, or CAS using Raven video feed and operator spot reports. Location of the video feed in the TOC/TAC is vital for timely use of Raven intelligence (see threat vignettes one [figure 5-4] and two [figure 5-5]).

THREAT VIGNETTE 1

During a battalion attack in a dense urban environment, a Raven launches before the LD of the ground maneuver element to locate the enemy and serve as a command and control asset to direct the ground maneuver forces. The commander uses the Raven feed remote directly from the RVT located on the roof of the TOC to engage located enemy personnel with 155-millimeter artillery rounds. By engaging enemy strongholds, the commander keeps the maneuver element out of contact and shapes the battlespace for the ground assault of the objective.

Once the maneuver element arrives at the scene, the Raven’s ability to look over walls and on top of buildings enables the commander to maneuver his forces to positions of advantage. Once the objective is secure, subsequent Raven teams continue to provide area security for the battalion.

Figure 5-4. UAS threat vignette one

THREAT VIGNETTE 2

A Raven conducting routine reconnaissance of an urban area detects individuals turning traffic around at an intersection near two large industrial buildings. Later, the Raven spots another group of individuals loading cars in a parking lot between the buildings. The Raven operator commands the UA to a lower altitude and identifies RPGs and mortar tubes in the cars.

The Raven team alerts the S2 that the men are moving weapons from the building and asks for further guidance. The commander views the video in real time at the TOC and sends a request via MIRC to the Air Force to take out the two buildings. At the same time, the commander alerts the QRF to be on standby to deploy to the site once the Air Force engages the buildings. The Raven's battery is getting low, but stays on station long enough to hand the target off to two Air Force F-16s.

The F-16s hit both buildings with two 500-lb bombs apiece. When the quick reaction force (QRF) shows up they find a huge cache of weapons and medical supplies. The QRF also finds enemy KIA in the area and speculates that there are more inside the collapsed buildings.

Figure 5-5. UAS threat vignette two

5-62. UAS and manned aircraft can provide excellent reconnaissance resolution when employed together (see threat vignettes three [figure 5-6] and four [figure 5-7]). The brigade and battalion commanders use UAS data to determine the best locations to employ manned air assets, greatly reducing the mission load of manned aircrews. Without UAS support, extended operations may require commanders to rotate manned aircraft or plan rest and resupply operations to maintain a continuous, limited reconnaissance effort. Manned aircraft frequently training with UAS exercise, as well as maximize the capabilities of this teaming, and assist the commander in selecting the best method of employment for different tactical situations.

THREAT VIGNETTE 3

On a night mission to provide surveillance of a designated ground brigade's NAI along a northbound convoy route, a UAS detects three suspicious vehicles traveling north along a road leading directly to a hostile city district. The vehicles stop alongside the road and appear to exchange large objects from one vehicle to another. Upon closer observation, the UAS team reports the object as a base plate for a 60-mm mortar system.

An attack helicopter (AH)-64D attack team diverts to the area to observe and report on the UAS observations. While the AH-64D team diverts, the vehicles stop alongside a building, set up their mortar system, and then fire three rounds toward the south into another city section. The insurgents disassemble their mortar quickly, load their vehicles, and then proceeded northbound along the road while the UAS team maintains a track and observation on the enemy.

Figure 5-6. UAS threat vignette three

THREAT VIGNETTE 4

While making a pass over a densely populated neighborhood, the optics of an UA identifies a seven-man mortar team with a white sedan firing mortar rounds into a coalition forward operating logistics base. Counterfire radar quickly picks up this information, and a plan for an air and ground interdiction is set in motion.

The ground brigade notifies the aviation brigade; in turn, the aviation brigade diverts a team of observation helicopter (OH)-58Ds to intercept the fleeing vehicles. The OH-58D team checks in with the ground brigade and receives a situation report. After a target handover from the ground brigade, the OH-58D team positively identifies the vehicle and the ground brigade clears the OH-58D team to fire. The aircrew disables the vehicle and kills one insurgent with .50-caliber machine-gun fire.

Figure 5-7. UAS threat vignette four

5-63. Using air-ground coordination, directed ground elements arrive at the scene of the engagement. When they arrive on location and inspect the vehicle trunk, they confiscate the 82-millimeter mortar and bipod used to conduct the attack, several 82-millimeter mortar rounds, as well as rocket propelled grenades and AK-47 assault rifles. The UAS team guides the AH-64D team to the area, confirms the individuals are not friendly, and receives the ground commander's approval to engage the three vehicles. Within minutes of coordination with the ground headquarters, the AH-64D team engages the target vehicles with 30-millimeter chain-gun fire and destroys the insurgent vehicles. The UAS team confirms the destruction of three vehicles in a BDA report. The reconnaissance, surveillance, and TA capabilities of UAS make them ideal to support reconnaissance and security missions. Locating HPTs, such as enemy AD or field artillery (FA) systems, is a critical mission for UAS. UAS can cue forces during screen, guard, and cover missions. UAS can perform all of the basic tasks of the screen except clearing an area, thus freeing the manned systems for higher priority actions within the covering force mission.

5-64. UAS linked to battalion R&S and intelligence and electronic warfare assets enhance operations. Maximum use of UAS and joint assets can significantly reduce the requirements on the commander's internal resources required for security. UAS units can perform all basic aeroscout observation tasks that reduce the demands on manned systems, thereby lessening manned system flying hour requirements and (or) fighter management needs. While TTP governing Army UAS operations are emerging, units should explore every opportunity to use UAS, including those of other services, to enhance military operations.

5-65. Communication and coordination with UAS operators are essential for the integration of UAS into the battlespace with manned assets. If a UAS unit is to conduct the screen of an area or accept handover to or from an attack reconnaissance unit, a detailed C2 plan ensuring proper coverage of the area is necessary. C2 of the UAS and manned system is further complicated when the staff controlling the UAS is located at another headquarters or at higher headquarters.

5-66. Combined UAS and air reconnaissance operations are excellent force multipliers. SOPs, battle drills, rehearsals, and training exercises contribute to success.

5-67. UAS will become an integral part of the communications infrastructure in the future, providing relay and extending the future networks ability to span the depth and breadth of a commander's AOR.

RECONNAISSANCE, SURVEILLANCE, AND TARGET ACQUISITION MISSIONS

5-68. UAS capabilities make them ideal to support R&S missions. Locating HPTs, such as enemy AD or FA systems, is a critical reconnaissance mission for UAS. UAS can aid in cueing supported forces during screen, guard, and cover missions. During economy of force missions, UAS can provide information on DPs triggering commanders to alert dispersed forces to mass their effects on a particular enemy force.

INTEGRATION WITH RECONNAISSANCE BATTALION EMPLOYMENT

5-69. Discussed below are three options for integrating manned aviation systems and UAS together.

Unmanned Aircraft System to Aviation Unit Handover

5-70. Commanders may direct UAS to handover targets to helicopters for numerous reasons, including—

- Confirm/deny enemy activity.
- Develop the situation.
- Engage the target(s).

5-71. When the decision is made to conduct a target handover, the target description, grid location (8-digit preferred), and direction of movement (if applicable) should be immediately passed to the aircraft. After helicopters reach the target area they guided onto the target by the UAS crew or TOC personnel viewing the personnel feed. In complex terrain such as urban environments, a grid coordinate is rarely enough to effectively handover a target. Road intersections, prominent buildings and other landmarks may be used to guide the helicopter crew to the target. During nighttime a target handover can be more easily facilitated when the UA is equipped with a laser illuminator. In low threat scenarios the helicopter may overfly the target to allow the UAS crew to confirm the proper target is handed over.

Aviation Unit to Unmanned Aircraft System Handover

5-72. The aviation reconnaissance unit acquires the enemy force and maintains observation. The aviation unit then hands over the target to the UAS using the same methods as above. The aircraft remains on station or bypasses enemy forces depending on the mission and Commander's guidance. Purposes for handing over targets to UAS include—

- Maintain contact (UAS has longer station time).
- Provide additional SA to aircraft and/or TOC.
- Provide stealth reconnaissance (aircraft departs - target may believe he is no longer being watched).
- Conduct BDA.
- Transfer risk from aircraft to UA.

Aviation Unit and Unmanned Aircraft System Sectors

5-73. METT-TC is the basis for aviation unit and UAS sector assignments. If the situation dictates, they can switch sectors. This maximizes the capabilities of both systems; however, it requires the most coordination. This option allows aviation units to extend AOs and concentrate manned elements on the most critical sector.

SCREEN MISSIONS

5-74. The size of the area depends on METT-TC, mission duration, and aircraft/aircrew/UAS availability. While every mission and situation is different, this section discusses how to calculate the area of coverage for a screen.

SCREEN MISSION TERMS

5-75. Figure 5-7 and figure 5-8 illustrate the following terminology and its application. They also offer example distances.

Manned-Unmanned Teams

5-76. A MUM team is a lead/wingman team operating with control of one or more UA. Manned aircraft may control both the UA and sensor package, just the sensor package with a GCS controlling the UA movements, or with the GCS controlling the UA and sensor package under manned aircraft direction. The UA may be lethal or nonlethal.

Rapid Response Team

5-77. Lightly armed teams on the screen line can rely on preplanned and (or) on-call fires and the more heavily armed rapid response team to destroy enemy reconnaissance assets if so ordered. A deception technique is to allow enemy reconnaissance assets to pass through.

Observable Area

5-78. The observable area is the area observed from an OP. Ideally, it is large enough that the observing team can move from one OP to other OPs and return before an enemy unit moves into the standoff zone. The observable area of a UAS may be larger dependent on the altitude of the UA, sensor package, and slant angle. The level of resolution and “look down” angle of UA imagery may limit vehicle detection and distinguish between threat and friendly and real versus decoy. Cloud cover may also obscure EO/IR sensor imagery.

Standoff Zone

5-79. The standoff zone is the area between the OP and observable area that provides protection from expected enemy direct-fire weapons systems. For UA, altitude plays a role in the size of the required standoff zone. Lower altitudes require more standoff.

Observation Posts

5-80. Aircrews use a series of OPs along the screen line to observe. UA fly a pattern above screen line OPs to detect enemy movement before the enemy can pass through the observable area. In addition, UAS can screen those areas unobservable by ground forces.

Terrain and Visibility Influence Screen Line Size

5-81. Factors that influence the size of a screen line include the following:

- Cross-compartmentalized, mountainous, or winding terrain affects the size of the observable area(s).
- Trafficability for ground forces. High-speed enemy avenues of approach decrease the time required for ground units to pass through the observable area.
- Illumination, IR crossover, and weather affect the size of the observable area and the standoff area.

- Distance to FARP(s) affects time on station.
- Distance between OPs affects the time required to move between OPs.

SCREEN PLANNING EXAMPLES (8-12 HOURS)

5-82. Figure 5-8 shows a single MUM team screening from OP 2. The terrain is constricted and the avenue of approach follows a valley. The standoff area is approximately 3 kilometers and the observable area is 5 kilometers. The manned aircraft can monitor the avenue of approach, while the UAS can expand security out to a greater range. The next avenue of approach is in the next valley, 10 kilometers away. The UAS of a MUM team provides an opportunity to expand the area the single MUM team can screen, in this case, by surveying the next avenue of approach in the next valley. Depending on visibility, the manned and unmanned aircraft can alternate between the two OPs, 10 kilometers apart. In contrast, without the UAS, concealed air route availability may prevent the air reconnaissance team from moving to the next valley and back again before the enemy can pass through the observable area. This requires the air reconnaissance team to maintain continuous observation from OP 2. Because it is mountainous terrain, and the aircraft and UA munitions load may not be sufficient to repel expected enemy reconnaissance forces, a rapid response team is on standby to repel or destroy enemy reconnaissance forces. MUM Team 1 observes, while MUM Team 2 moves to, in, or from the FARP. Team 3 positions itself where it can react to any enemy force observations. Alternate kill zones are selected south of the observed area in case the enemy moves faster than expected through the observable area.

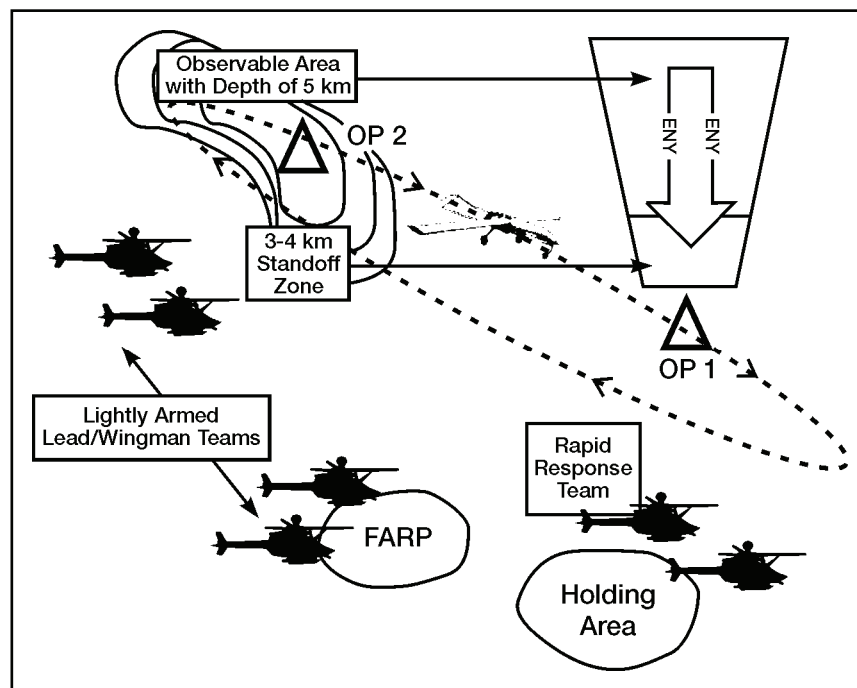

Figure 5-8. Screen with rapid response team

5-83. Figure 5-9 shows two MUM teams screening along OPs 1 through 4. The terrain is open and allows excellent standoff and observable areas. The standoff area for each is approximately 3 kilometers. The observable area for manned aircraft is approximately 5 kilometers along each avenue of approach. The distance between OPs is 15 kilometers. An attack helicopter team provides the rapid response team. The air reconnaissance teams rotate through the screen areas and the FARP. MUM Team A moves to the area defined by OPs 1 and 2, MUM Team B moves to the area defined by OPs 3 and 4. They observe for approximately 40 minutes, then MUM Team C relieves MUM Team A, MUM Team A relieves MUM

Team B, and MUM Team B moves to the FARP. This rotation continues until another ground or air unit relieves the attack reconnaissance company, making enemy contact, mission complete, or crew endurance requires the air reconnaissance teams to return to the AA.

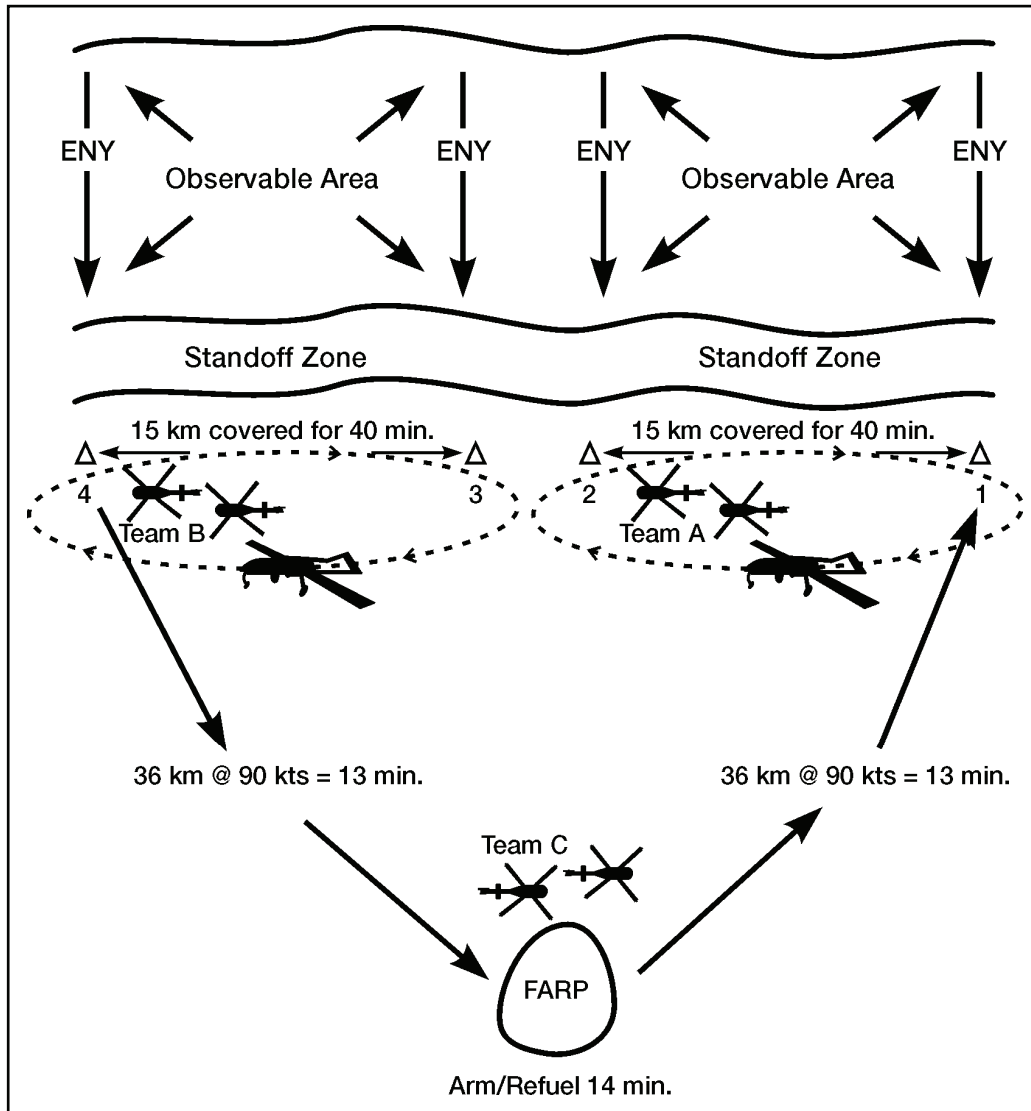

Figure 5-9. Maximum screen line option

5-84. The MUM team leader must establish a rotation of UA for servicing in the same way manned aircraft rotate through the FARP. UA generally have longer endurance than manned aircraft. Therefore, as the MUM team manned aircraft rotate to the FARP, teamed UA continue observation and transition to the next observation area during servicing of manned aircraft. Manned aircraft receiving service in the FARP continue to monitor UAS video imagery and receive other data, but cannot transmit directions to the UA via the GCS while arming and refueling.

SCREEN PLANNING CALCULATIONS (8-12 HOURS)

5-85. Screen planning calculations require making assumptions and careful, detailed planning. The observable area and the enemy's assumed movement speeds determine how long and how often friendly forces must observe from selected OPs. Air speed and OP occupation times determine the time it will take to move between OPs and into position. Each requires knowledge of the enemy, careful planning, and adherence to schedules.

5-86. In the scenario depicted in figure 5-8, each team can cover two OPs because each team can travel from its first OP to the second, observe, and then return to the first OP before the enemy can traverse the observable area. The air reconnaissance team requires approximately 7 to 8 minutes at 60 knots to travel between each OP, and approximately 1 to 5 minutes moving into the OP, unmasking, observing, masking, and moving out of the OP. This provides a 2-minute buffer for the air reconnaissance team to move between OPs.

5-87. The scenario depicted in figure 5-9 also requires a reaction force. The time required for the screening air reconnaissance team to travel between OPs is too long to cover more than one at a time, therefore requiring the entire company to cover that single approach. However if employing a MUM team, UA may remain near the original OP while manned aircraft transition to the second OP and a reaction force remains available at a holding area.

5-88. Outlined in figure 5-10 is the formula for planning times. The formula for planning ground unit speed is in figure 5-11.

<p>Flight time computation:</p> $T = \frac{D \times 60}{S \times 1.85}$ <p>T = Time in minutes D = Distance in kilometers S = Ground speed in knots</p> <p>Airspeed/ground speed conversion: Note: The number 60 converts hours to minutes. The number 1.85 converts knots to kilometers/hour. Round fractions to the nearest whole minute.</p> <p>Example: given 50 km distance from OP 4 to the FARP at an average groundspeed of 90 knots.</p> $T = \frac{50 \text{ km} \times 60}{90 \text{ kn} \times 1.85}$ $T = \frac{3,000}{166.5} = 18 \quad \text{minutes of flight time from OP 4 to the FARP at 90 knots.}$ <p>Sample groundspeeds in knots converted to rounded off km/hr and km/min: 65 kn = 120.4 km/hr = 2.0 km/min.....100 knots = 185.2 km/hr = 3.1 km/min. 80 kn = 148.2 km/hr = 2.5 km/min.....110 knots = 203.7 km/hr = 3.4 km/min.</p>

Figure 5-10. Computing en route time

<p>To compute the time required for an enemy or friendly ground unit to pass through an observable area, use the following formula:</p> <p>Observable area in kilometers X 60 = time in minutes for ground unit to pass divide by groundspeed in kilometers/hour</p> <p>Example: If the observable area is 5 km and the enemy unit's groundspeed is 20 km/hr, find how long, in minutes, it will take the enemy unit's lead elements to pass through the observable area. Observable area = 5 km, Groundspeed = 20 km/hr</p> $5 \times 60 = 300 \text{ divided by } 20 = 15 \text{ minutes}$

Figure 5-11. Computing ground unit movement time

24-HOUR SURVEILLANCE PLANNING

5-89. The following discussion is an example of a technique to provide 24-hour surveillance. Surge operations may require the attack reconnaissance company/troop and UAS unit to provide continuous day and night coverage. Employing four-day and four-night crews allows an attack reconnaissance company/troop to screen for about 24 hours. Employing two-day and two-night crews and teaming them with the attack reconnaissance company/troop teams allows a UAS unit to screen for about 24 hours. Table 3-1 of both AR 95-1 and AR 95-23 is a common crew endurance guide that recommends a maximum flight time of 8 hours in a 24-hour period and 15 hours in a 48-hour period. It also specifies environment relative factors multiplied by actual flight hours to reflect the additional strain of certain types of flight. The duty day for aircrews can be up to 16 hours for a 24-hour period and 27 hours for a 48-hour period.

MOVEMENT TO CONTACT

5-90. Implement movement to contact to develop the situation or establish or regain contact with the enemy. A UAS and (or) MUM team performs the movement to contact, similar to a zone reconnaissance with a focus on finding the enemy force and developing the situation. Units conduct terrain reconnaissance to support locating the enemy. As a result, a movement to contact mission proceeds much faster than a zone reconnaissance. The mission culminates in either termination or contact with the enemy, at which point the MUM team often execute a hasty attack or the UAS carry out surveillance with the commanders discretion to engage the enemy.

AERIAL TARGET DESIGNATION

5-91. Aerial target designation allows a UAS to provide lock-on after launch capability for laser engagements (figure 5-12 through figure 5-14), using Hellfire or similar munitions fired from rotary wing aircraft. This is a dynamically retaskable mission, and is available any time an aircraft equipped with the tri-sensor payload is flown.

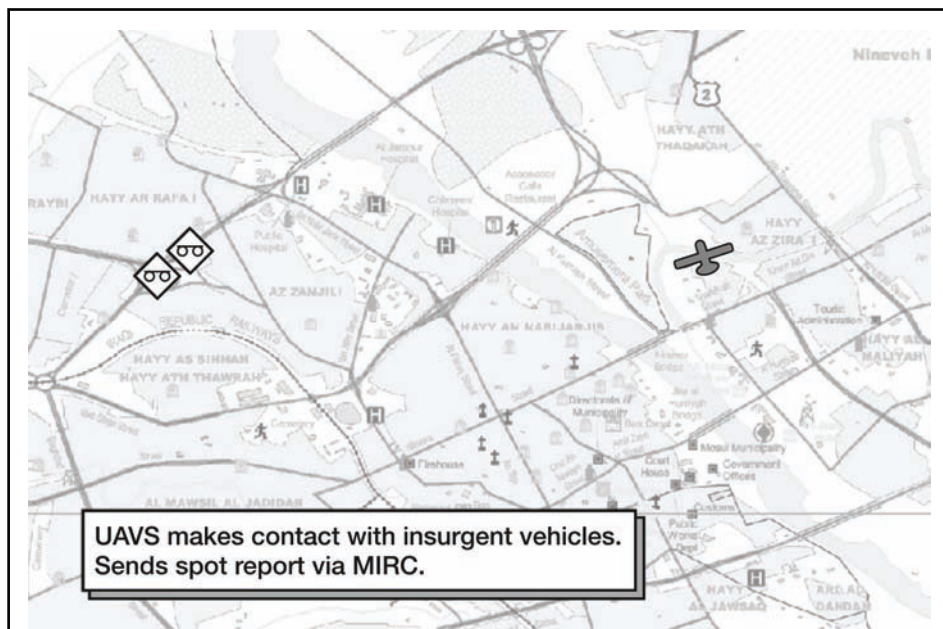

Figure 5-12. Laser engagement one

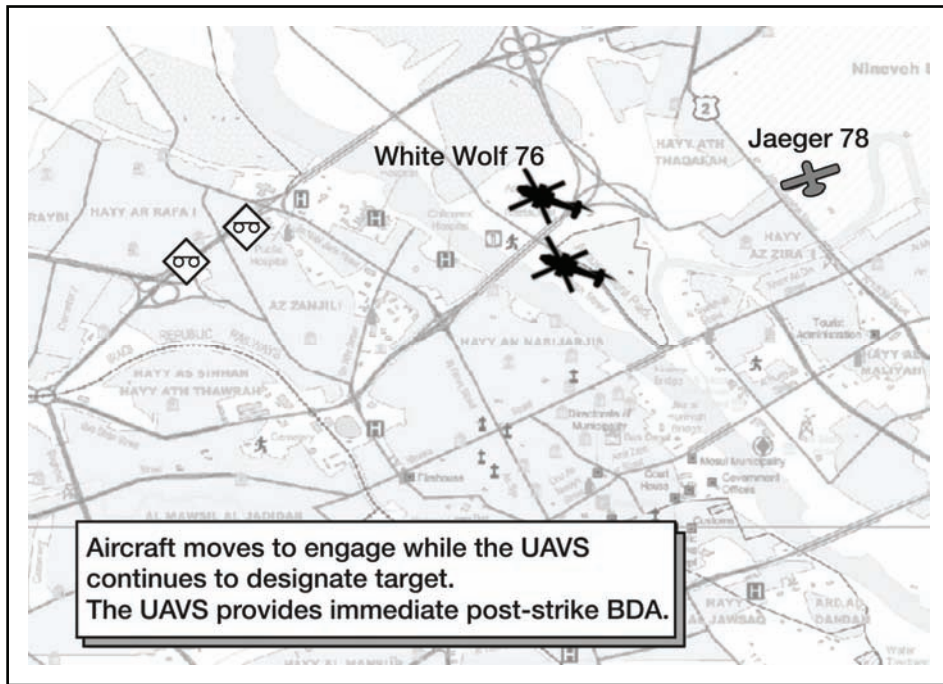

Figure 5-13. Laser engagement two

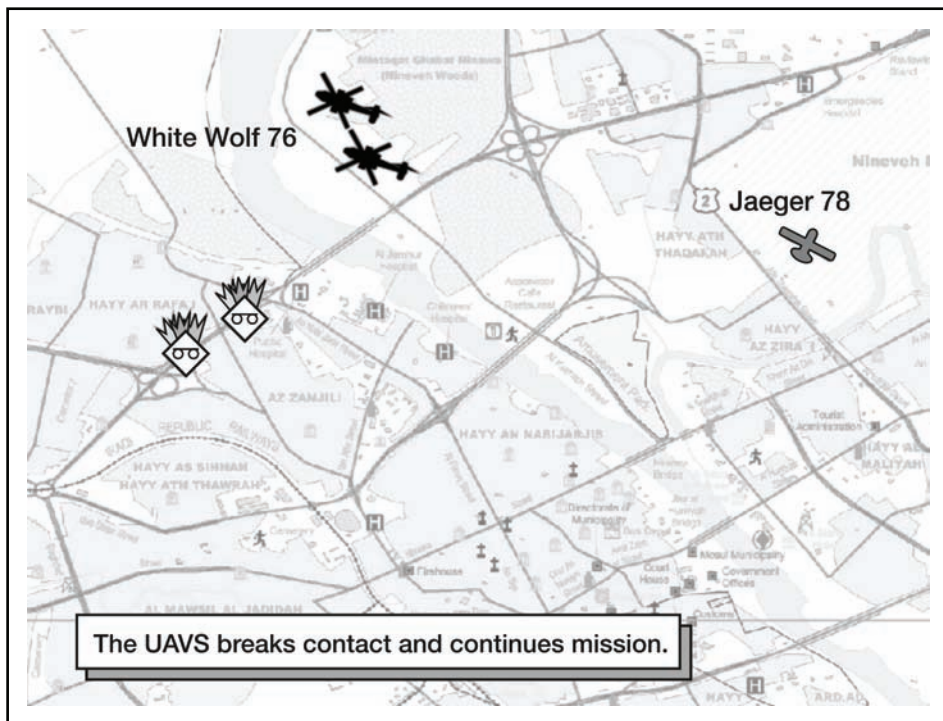

Figure 5-14. Laser engagement three

5-92. During flight, the UAS aircrew detects and recognizes a target that meets preexisting criteria (mortars firing at U.S. troops, insurgents armed with RPGs, and others).

- The ground commander (with the appropriate level of release authority) directs target engagement.
- The UAS crew passes laser code and laser target line information to the helicopter while the UA maneuvers into best position for target designation.
- Recommended minimum altitude block is 2000 feet with a 5 by 3 kilometer orbit.
- The UAS establishes a laser target line that allows for the longest possible laser designation time.
- The helicopter maneuvers into position and announces ready to fire. The helicopter ensures that the UAS is within 60 degrees either side of the helicopter but outside of the Hellfire exclusion zone (see FM 90-20). The optimal angle between shooter and designator for UAS/rotary wing Hellfire operations is 45 degrees.
- The ground commander authorizes fire (any time before engagement).
- The UAS ensures proper target designation and directs the helicopter to fire.
- Helicopter fires and announces missile away.
- After engagement, the UAS provides BDA.

ARTILLERY FIRE SUPPORT

5-93. UAS provide accuracy for adjusting artillery fire. Not only does the UAS allow the TOC to see the rounds impact, it provides the opportunity to adjust the round accurately from the moment of impact, thus allowing maximum rounds down range in less time to destroy a target. Forward observers (FOs) can observe the battlefield at a much greater distance and with an aerial perspective. This perspective allows FOs to see 360 degrees around the target. Because UA can fly great distances and at high altitudes, artillery observers now can call fire on targets that are tens and hundreds of miles away from the observer's location.

MISSION PLANNING

5-94. To have tasking authority and call for fire ability in the appropriate locations, mission planners must ensure they meet following requirements:

- In the TOC, a trained observer should be available to conduct the mission. UAS video must also be available either directly from the UA or sent through the GCS. The TOC must have communications with the GCS and the firing unit. Having the GCS located in the TOC can simplify C2 and provide for more timely fires.
- At the forward tactical node, remote video from the UA must be available. The forward node must have communications with the GCS.
- In the GCS, the UAS pilot, payload operator, or MC should be trained in call-for-fire procedures. If not, an observer is attached to the GCS. The GCS must have communications with the firing unit.

MISSION EXECUTION

5-95. Once the mission is under way, the C2 node that controls the UA will dynamically task the UAS. The tasking of the UAS will be locating specific targets and, at the end of each FS mission, retasked to locate the next target. In some cases, the tasking of the UAS could be locating more than one target at a time, or what artillerymen call simultaneous missions. Operators use call for fire procedures from FM 6-30 and the Joint Fire Multi-Service Procedures for the Joint Application of Firepower (J-Fire) manual (FM 90-20) to attack the target using indirect fires.

5-96. Once RVT setup is complete, using it to call for fire on targets and adjust artillery fires is relatively easy. FOs use the same procedures they would for normal fire missions. Many RVTs display only the video, and do not display information found on the video screens in the GCS. The location the sensor is viewing, a critical piece of information, assists the FO in determining accurate target location. If no location is displayed on the screen, FOs must ask the GCS operators what grid is on display on their screen. To assist with artillery adjustment, FOs must understand terrain association, when to zoom the cameras in and out (or work with the GCS crew to do this) to search for targets and capture the impacting rounds, and how to adjust rounds using 6,400 mils as direction.

5-97. The following is a chronological example of an executed FS mission using a UAS:

- The UA arrives on station at a predestinated location to support the mission.
- The GCS contacts the tasking authority (for example, TOC) and provides a check-in briefing.
- The tasking authority gives the GCS a situation update. The update may include the unit mission, enemy disposition, friendly positions, and current FS considerations.
- Final communications checks conducted.
- UA sensors are oriented on suspected target area.
- Suspected target are detected.
- Target identified and located.
- Target location validated.
- Call for fire sequence initiated using call-for-fire procedures.
- When only video (such as no coordinates displayed on screen or artillery adjustment software) is used to make adjustments, the observer must use 0 or 6,400 mils as direction for making corrections on subsequent rounds.
- After target engagement, observer uses UAS video to help assess effects on target.
- The observer ends the fire mission using standard call-for-fire procedures and reports BDA to the FS system at the end of mission transmission as per FM 6-30/J-Fire manual (target refinement, end of mission, BDA).
- After mission completion, the tasking authority provides a new tasking or instructions to the UAS (such as look for new target, re-attack previous target, return to base, and so forth).

CLOSE AIR SUPPORT

5-98. In the simplest scenario of UAS integration into CAS, a JTAC using UAS video to build SA of the target area locates in defilade or masked targets, generates target coordinates, verbally talks the aircraft onto the intended target, and gives verbal corrections to follow on aircraft for weapons impact onto a target. The JTAC could be in a vehicle or on the ground near the target area, in a GCS, or in a TOC many miles away from the fight. In a more complex scenario, the JTAC uses the UA's laser target designator to guide laser-guided munitions from other strike aircraft onto targets. If the UA is armed, it can be used to locate targets as well as engage with its own weapons payload.

5-99. CAS operations are carried out in accordance with JP 3-09.3.

COMMAND AND CONTROL OPTIONS

5-100. The following C2 options pertain to UAS in CAS:

Option A

5-101. The JTAC is the primary release authority and has direct communications with another node receiving video and relaying target area SA to the JTAC via radio link. The JTAC can view the general target area but not the specific target. The JTAC uses this information to talk the aircraft onto the target. The ground commander chooses the type of terminal control per ROE or theater SPINS.

Option B

5-102. The JTAC with a RVT is the primary release authority and has direct communications with the GCS payload operator via voice. The ground commander will choose the type of terminal control per ROE or theater SPINS.

Options C and D

5-103. A qualified JTAC is located away from the battlefield in the GCS (Option C) or a TOC (Option D) and has video feed and voice or chat with the UAS crew. The JTAC is in direct voice contact with ground forces and strike aircraft. The JTAC has a clear picture of friendly positions and a solid understanding of the ground element's maneuver scheme. Only Type 2 and Type 3 control is available for terminal control.

Option B/C Hybrid

5-104. The JTAC is the primary release authority and has direct communications with the UAS MC and CAS aircraft. Cueing of the JTAC on to the target location is completed via voice with the UAS MC. The JTAC can view the target area but not the specific target. The JTAC uses this information to talk the aircraft onto the target. The ground commander chooses the type of terminal control per ROE or theater SPINS.

RECOMMENDED FLIGHT PROFILES

5-105. When an UA is supporting fixed-wing CAS, a 5 by 3 kilometer orbit minimum with a 2,000-foot altitude block is recommended. The UA flight profile should parallel the final attack heading of the attack aircraft. This allows the UA to provide laser target marking for laser-capable aircraft or to complete terminal guidance of laser-guided ordnance. The JTAC and strike aircraft finalize the exact delivery tactics before target engagement. On egress, the strike aircraft should turn away from the UA orbit to reduce the risk of flying through the laser.

KILL BOX

5-106. A kill box is a three-dimensional FSCM used to facilitate the expeditious air-to-surface lethal attack of targets, which may be augmented by or integrated with surface-to-surface indirect fires. A kill box may contain other measures within its boundaries (for example no-fire areas, restricted operations areas [ROAs], airspace coordination areas, and others). Restrictive FSCMs and ACMs always have priority when established in a kill box.

5-107. When established, the primary purpose of a kill box is to allow air assets to conduct interdiction against surface targets without further coordination with the establishing commander and without terminal attack control. The goal is to reduce the coordination required to fulfill support requirements with

maximum flexibility while preventing fratricide (see FM 3-09.34). The Air Land Sea Application Center is responsible for the multi-service tactics, techniques, and procedures for undertaking kill box operations.

5-108. Component commanders establish and adjust a kill box in consultation with superior, subordinate, supporting, and affected commanders. The kill box is an extension of existing support relations established by the JFC. Kill box boundaries normally are defined using an area reference system such as the Common Geographic Reference System (CGRS) (figure 5-15), but could follow well-defined terrain features or may be located by grid coordinates or by a radius from a center point.

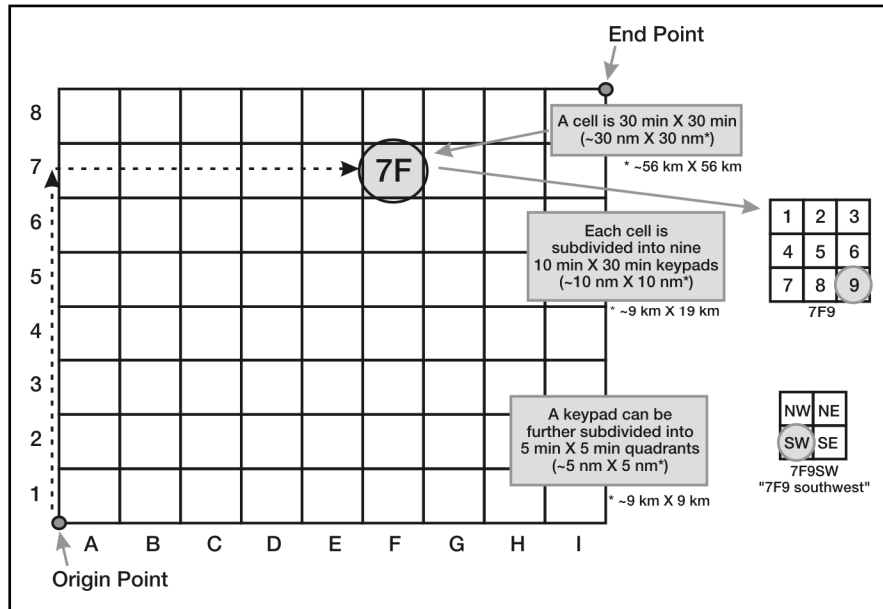

Figure 5-15. Common Geographic Reference System

5-109. Kill boxes are shown in figure 5-16. Surface-to-surface direct fires are not restricted by a kill box.

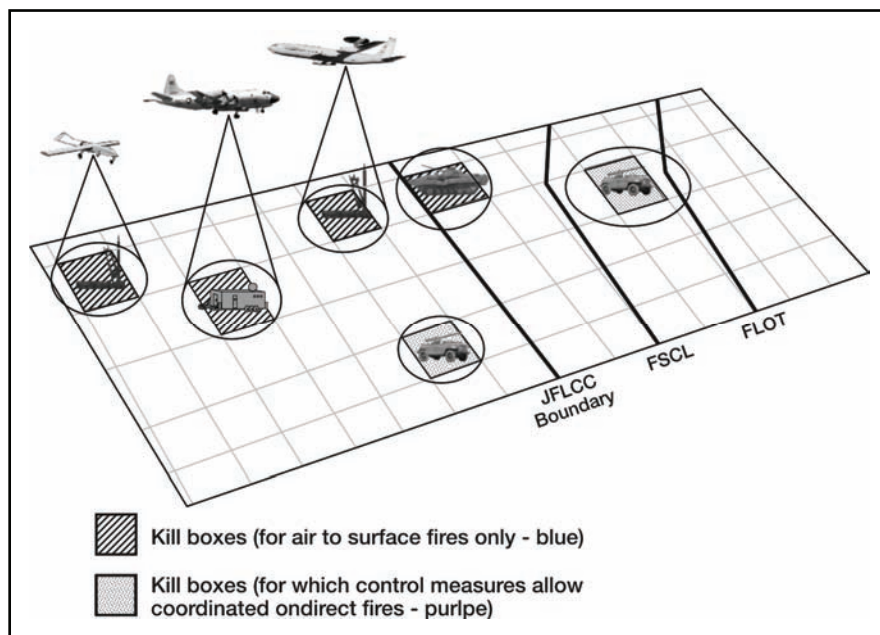

Figure 5-16. Representative kill box locations

5-110. The authority over kill box status, whether short of or beyond the fire support coordination line (FSCL), rests with the supported commander. Concurrence with the joint force land component commander is mandatory for opening any kill box short of the FSCL to ensure all land forces are clear of the designated area. Deployed with the land force, the Air Support Operations Center is normally the theater air control system element responsible for airspace short of the FSCL, the ideal agency to coordinate the opening and closing of kill boxes in that zone. For operations beyond the FSCL and AWACS, the Control and Reporting Center or the Air and Space Operations Center will likely be the agencies to contact to determine kill box status. Integration of air-to-surface and surface-to-surface fires requires application of appropriate restrictions such as altitude, time separation, or lateral separation. The supported commander will determine which of these is appropriate for the mission and ensure dissemination through the appropriate C2 nodes. Kill boxes are complementary to and do not preclude or conflict with other FSCMs, and are employed on either side of the FSCL. To use kill boxes in this manner, it is critical to use the same CGRS throughout the joint operations area.

SECTION V—PERSONNEL RECOVERY

5-111. Refer to JP 3.50 for overall joint tactics, techniques, and procedures (JTTP) and definition of terms.

5-112. In a personnel recovery (PR) environment, the distinctive sound of an UA can be a two-edged sword. Some isolated personnel have reported the noise serves to highlight a rescue attempt is in progress, and provides an immediate morale boost signaling them to prepare for recovery. On the other hand, the presence of an UA in the area can heighten enemy alertness and therefore increase threat response to the PR TF. By deliberately offsetting the UA orbit, PR mission planners can use the UA's noise signature to draw enemy forces away from the survivor's location.

5-113. The endurance of an UAS could make it useful for verifying the go/no-go criteria (such as the friendly and enemy tactical situation) used to trigger or cancel a rescue mission.

MISSION EXECUTION

5-114. A PR effort can be broken down into five distinct phases:

- Report: Notify appropriate organizations that personnel have or may have become isolated.
- Locate: Precisely find and confirm the identity of isolated personnel.
- Support: Provide mental, physical, and emotional support to the isolated personnel.
- Recover: Coordinate actions and efforts to bring isolated personnel under the control of a recovery force.
- Repatriate: Return of recovered personnel to the control of a team or organization in the theater reintegration process.

5-115. UAS can have a role in the first four phases of a PR mission.

REPORT

5-116. A UAS crew may be the first party to become aware of a PR situation through visual or electronic means. Once aware, the UAS crew may be able to use the onboard radio to communicate either directly with the isolated person or nearby friendly forces that may have observed the isolating event (for example, a wingman) or may be able to recover the isolated person quickly. Many UAS have direct connectivity to the highest echelons of command in the theater, and they can relay the developing PR situation with little or no delay.

LOCATE

5-117. Once in the area, UAS use the EO/IR sensor to locate isolated personnel. The soda-straw effect of the payload sensor requires off-board cueing to the isolated personnel location. UAS—

- Attempt contact using an onboard radio, if so equipped.
- Stream video and pass updated location via secure means.

5-118. Because of long endurance, UAS are a good asset to loiter during the planning of a PR mission and can provide continuing information as the situation develops.

5-119. Because of slow transit speeds, the UA may not be able to reach the isolated personnel's location in a timely manner.

5-120. The UAS crew can attempt to certify, through the onboard radio, any authentication information.

SUPPORT

5-121. UAS in the support capacity—

- Can provide over-watch of enemy activity.
- Possible airdrop needed supplies such as a radio or food (future capability).
- Direct the isolated personnel to caches or friendly forces or away from enemy forces, hazardous terrain, and other dangers.
- Provide psychological and emotional support.
- Use on-board weapons to suppress threat.
- Buddy laze for strikers using laser target designator.
- Mark targets using IR pointer.

RECOVER

5-122. UAS in the recover capacity—

- Use EO/IR sensor to assess planned ingress and egress routes and terminal areas.
- Use RVT to equipped ground units to increase SA/SU to recovery forces.
- Provide force protection support to include—
 - Observe possible enemy areas (avenues) of approach.
 - Prevent enemy sanctuary and freedom of movement.
 - Identify danger areas and ambush sites.
 - Convoy protection.
- Identify and assess status of LZs and recovery areas—
 - Use on-board weapons to suppress threat.
 - Buddy laze for strikers.
 - Mark targets using the IR pointer.

5-123. It is imperative UAS stay one-step ahead of the PR TF. As the TF is marshalling at a rendezvous point, UAS should start surveying the ingress route for enemy activity. As the TF progresses toward the pickup point, UAS should survey the LZ and its perimeter. Finally, as the rescue unit enters the LZ, the UAS should already be transiting the egress route. The intent is to provide information to the AMC and on-scene commander far enough in advance so they can implement execution options in a timely and effective manner. UAS should avoid direct overflight of all preplanned routes and the survivor's location as this serve to highlight friendly forces and their intent. Rather, UAS should offset as far away as the sensor's effectiveness allows while flying a seemingly random profile to conceal the TF's intentions.

Chapter 6

Sustainment Operations

UAS operations consist of many interrelated functions that depend on a responsive supply system and thorough maintenance program. Planning, managing, and executing supply support and maintenance involves synchronization and seamless integration. At all levels of operations, logistics and maintenance are key sustainment functions.

SECTION I—GENERAL

LOGISTICS

6-1. Supply procedures and policies are located in AR 710-1, AR 710-2, AR 710-3, DA Pam 710-2-1 and DA Pam 710-2-2. Supply operations information can be found in FM 3-04.500, FM 4-0, joint publication (JP) 4-0, and JP 4-03.

6-2. Unlike many other organizations on the battlefield, a UAS deployed and dispersed geographically across the theater, corps, and division, requires sustainment from forward units regardless of any C2 relations. Table 6-1 shows the logistic responsibilities for each class of supply as it applies to UAS only and not the individual Soldiers. For example, no Class III is required for the Raven because the UA has an electric motor requiring batteries instead of liquid fuel.

Table 6-1. UAS Logistic Responsibilities

Class	RQ-5/MQ-5 Hunter Company	RQ-7 Shadow Platoon	RQ-11 Raven
I	Organic unit	Supported unit	Organic/Supported unit
II	Organic unit	Organic unit	Organic/Supported unit
III	Organic unit 100 low lead aviation gasoline (AVGAS) only	Supported unit. Take 5-gallon cans to the brigade support battalion for motor gasoline (MOGAS).	N/A Batteries only
IV	Organic unit	Supported unit	Organic/Supported unit
V	Organic unit	N/A	N/A
VI	Organic unit	Supported unit	Organic/Supported unit
VII	Organic unit	Organic unit	Organic/Supported unit
VIII	Organic unit	Supported unit	Organic/Supported unit
IX	Organic unit	Supported/Organic/CLS where appropriate.	Project Manager's Office-UAS parts sent to unit.

6-3. Currently, no UAS status report requirement exists. The logistics staff officer (S4) should consider the following items when developing a method to monitor and anticipating UAS logistical needs:

- UA status.
- GCS.
- GDT/launch recovery terminal.
- Landing system (TALS or EP).
- Payload status.
- Supporting equipment status.
- Hours/days of AVGAS/MOGAS/battery availability.
- Projected parts needed (scheduled maintenance).
- Not mission capable supply parts requested.
- CLS requirements.

MAINTENANCE

6-4. The electronic warfare/intercept (EW/I) systems repairer (MOS 33W) performs the following maintenance functions on their respective components of the UAS:

- Fault detection and isolation.
- Removal and replacement of inoperative chassis mounted components and line replaceable units (LRUs) down to card level.
- Functional tests and built-in tests (BITs).
- Periodic inspection or replacement to comply with scheduled maintenance requirements, corrosion prevention, detection, and removal.
- Electronic maintenance covering payloads and electronic-based components repair by removal and replacement of LRUs.

6-5. The power generation equipment repairer (MOS 52D) performs the following maintenance functions on their respective components of the UAS:

- Fault detection and isolation.
- Removal and replacement of inoperative chassis mounted components and LRUs down to card level.
- Functional tests and BITs.
- Periodic inspection or replacement to comply with scheduled maintenance requirements, corrosion prevention, detection, and removal.

6-6. Maintainer MOSs 33W and 52D receives the following ASIs when school-trained for that particular UAS:

- ASI U2 for RQ-7 Shadow UAS.
- ASI U3 for RQ-5/MQ-5 Hunter UAS.

6-7. Field maintenance for UAS operators (MOS 15W) consist of maintenance tasks intended to keep the system operational and prevent deterioration. Operators will perform—

- Preventive maintenance checks and services.
- Preoperational tests to verify that the system is ready to operate using BITs.
- Visual inspection and a BIT analyzer.

6-8. The operator MOS 15W will receive the following ASIs when school-trained for that particular UAS:

- ASI D7 for RQ-7 Shadow UAS.
- ASI E7 for RQ-5/MQ-5 Hunter UAS.

6-9. Sustainment maintenance personnel perform UAS component repair, part replacement, fault detection, and fault isolation of specific parts. At this level of maintenance, maintainers focus on the repair of component items and their return to the distribution system. Component repair includes items such as major assemblies, LRUs, and repairable line items. Corps and theater maintenance activities, special repair activities, or contractors on the battlefield can perform sustainment maintenance.

6-10. Sustainment maintenance actions typically involve repair of repairable Class IX components, off-system, for return to the supply system. Uniformed maintenance personnel, DA civilians, or contractors can perform sustainment maintenance. The decision to have sustainment maintenance includes detailed off-system inside-the-box repair of LRUs through shop replaceable unit repair/replacement, and rebuild of engines, transmissions, and the like.

SECTION II—UNMANNED AIRCRAFT SYSTEM ORGANIZATIONS

RQ-1L I-GNAT

6-11. CLS personnel operate and maintain the I-Gnat. The approved two-tier maintenance system (field and sustainment) is the basis for I-Gnat logistics and maintenance.

6-12. Army units may assist I-Gnat maintenance personnel when possible by facilitating timely maintenance through the issuing of common tools, common hardware (nuts, bolts, washers, and the like), and general maintenance advice and assistance, recovery support, and any other command authorized assistance that ensures or enhances system availability and mission accomplishment (AR 95-20).

RQ-5/MQ-5 HUNTER

6-13. Hunter UAS units have the same responsibilities as other units to request and obtain supplies and logistics. The initial entry force carries 72 hours worth of Class I (food and water) and Class III (petroleum, oils, and lubricants [POL]) and 120 hours of Class IX. The following is a breakdown of unique requirements by class of supply:

- Class III. For Hunter units, this is a complicated class of supply. The current Hunter UA with Moto-Guzzi engines use 100 low lead (100 LL) AVGAS only as per UAS-program manager (PM) Field Notice 05-02 (RQ-5A) – Hunter Short Range Unmanned Aircraft System – Mandatory – Use of 100 low lead AVGAS dated 8 June 2005. The organic brigade will provide all Class III.
- Class IX. Contact repair teams deliver all system peculiar repair parts. When deployed away from the battalion, the supported unit or forward support battalion (FSB) provides common items.

6-14. The maintenance section is part of the launch and recovery platoon and consists of eight 33W EW/I system repairers and six 52D power-generation equipment repairers. The maintenance section performs system maintenance, launch and recovery operations, and additional duties associated with L/R site emplacement, the preparation of the UA for launch and recovery, in addition to their MOS specific tasks. One of the maintenance section's 33W's and 52D's function as the commander's quality assurance (QA) inspectors, ensuring maintenance performed on unit's UA and shelters is in accordance with approved publications. The CLS team consists of five field service representatives that include one mechanic, one technician, two VOs, and one QA inspector.

6-15. Life cycle CLS is the basis for the Hunter UAS maintenance concept. This maintenance approach means that the Hunter UAS unit will continue to have a CLS team assigned. Army maintenance personnel will provide routine field maintenance.

6-16. Army maintenance personnel perform field maintenance onsite. Field maintenance includes UA assembly and disassembly, preflight and post-flight checkouts and inspections, minor structural repairs and servicing, and troubleshooting and repair (primarily LRU removal and replacement). BIT procedures support fault location and diagnostics to the LRU level and objective card level. Once the fault has been

located, personnel evacuate the faulty item to a sustainment (depot) facility. The CLS team will assist the Army maintenance personnel where and when needed.

6-17. Units use sustainment maintenance for major UA components, propulsion system, control and autopilot systems, GCS, and data link and communications suite repair to component level. Sustainment (depot) facility will also provide software maintenance.

RQ-7 SHADOW

6-18. Shadow UAS units have the same responsibilities as other units to request and obtain supplies and logistics. The initial entry force carries 72 hours worth of Class I (food and water) and Class III (POL) and 120 hours of Class IX. The following is a breakdown of unique requirements by class of supply:

- Class III. For the Shadow UAS, this is a complicated class of supply. The current Shadow UA engine uses MOGAS. The supported brigade will provide all Class III.
- Class IX. Contact repair teams deliver all system peculiar repair parts. When deployed away from the battalion, the supported unit or FSB provides common items.

6-19. The complete Shadow UAS fits into four HMMWVs with shelters (two GCSs, a maintenance shelter, and an AVT) and includes an UA launcher trailer and maintenance trailer. Two cargo/troop carrying HMMWVs with one trailer are included for personnel and their equipment (rifles, helmets, camouflage netting, individual protective equipment, and so forth) and enough Class I (subsistence), Class III (POL) and Class IX (repair parts) supplies for initial operations.

6-20. The Shadow UAS maintenance section consists of four-33W EW/I system repairers and three 52D power-generation equipment repairers. The maintenance section performs system maintenance, launch and recovery operations and additional duties associated with L/R site emplacement, and the preparation of the UA for launch and recovery, in addition to their MOS-specific tasks. One of the maintenance section's 33W's and 52D's function as the commander's QA inspectors, ensuring maintenance performed on unit's UA and shelters is in accordance with approved publications. The mobile maintenance facility (MMF) consists of two CLS personnel. The MMF support plan is currently under development.

6-21. The life cycle CLS is the basis for the Shadow UAS maintenance concept. This maintenance approach means the Shadow UAS unit will continue to have a CLS team assigned. Platoon maintenance personnel will provide routine field maintenance. Higher-level maintenance will be accomplished at the forward repair activity and (or) the Electronic Service Support Center within theater to allow for quick turn around of critical system components.

6-22. Platoon maintenance personnel perform field maintenance onsite. This includes UA assembly and disassembly, preflight and postflight checkouts and inspections, minor structural repairs and servicing, and troubleshooting and repair (primarily LRU removal and replacement). BIT procedures support fault location and diagnostics to the LRU level and objective card level. Once the fault has been located, personnel evacuate the faulty item to a sustainment maintenance facility.

6-23. Units use sustainment maintenance for major airframe components, propulsion system, control and autopilot systems, GCS, and data link and communications suite repair to component level. The sustainment maintenance facility will also provide software maintenance.

RQ-11 RAVEN

6-24. Operators receive training to perform basic repairs. The makeup of the entire system consists of replaceable components.

6-25. Field maintenance typically includes routine inspections, servicing, cleaning, and adjusting. Field level maintenance procedures do not require specialized training or tools.

6-26. If the repair is not at an operator (field) maintenance level, it must be turned-in to unit supply/S4.

6-27. Send all questions regarding the Raven system to the following email address:
raven@tuav.redstone.army.mil.

This page intentionally left blank.

Appendix A

Army Unmanned Aerial Systems Mission Planning and Flight Checklists

This appendix provides unit commanders and staffs information and checklists for planning and coordinating UAS operations. UAS may be found anywhere on the battlefield. Army UAS units are limited to I-Gnat contractor supported elements, Hunter companies, Shadow platoons, and Raven systems issued to individual units.

MISSION PLANNING CHECKLIST

A-1. The mission planning checklist (table A-1) gives the staff specific points of consideration when planning for integration of UAS. UAS units can also use this checklist to prepare for supported unit requests for information. The UAS unit will do the planning. The checklist is not all-inclusive and will vary based on METT-TC.

Table A-1. UAS mission planning checklist

<i>UAS Mission Planning Checklist</i>	
Duty assignments: <input type="checkbox"/> Authorized MOSs on-hand <input type="checkbox"/> Critical MOSs identified and on-hand <input type="checkbox"/> Additional personnel necessary for 24-hour operations (if commander directed)	
Enemy situation: <input type="checkbox"/> Unit/order of battle (OB)/uniforms <input type="checkbox"/> Battalion/company locations plotted on map <input type="checkbox"/> Strengths/weaknesses <input type="checkbox"/> Most probable COA <input type="checkbox"/> Most dangerous COA <input type="checkbox"/> ADA threat (for each weapon system)	
	System Location plotted on map Maximum/minimum range (threat rings plotted on map) Minimum engagement altitude Strengths Weaknesses How to defeat
<input type="checkbox"/> Night vision capability	
<input type="checkbox"/> EW threat	
<input type="checkbox"/> Meaconing, interference, jamming, and intrusion (MIJI) of UAS uplink/downlink	

SAMPLE

Table A-1. UAS mission planning checklist

UAS Mission Planning Checklist	
<input type="checkbox"/>	CBRN threat
<input type="checkbox"/>	UA should avoid CBRN presence Place M9 paper on UA
Friendly situation:	
<input type="checkbox"/>	Brigade mission/intent
<input type="checkbox"/>	Battalion mission/intent
<input type="checkbox"/>	Maps or imagery of operating area
<input type="checkbox"/>	Friendly unit location (brigade headquarters plotted on map)
<input type="checkbox"/>	Friendly graphics posted on map
<input type="checkbox"/>	UAS readiness status
<input type="checkbox"/>	Supported unit task/purpose
<input type="checkbox"/>	Adjacent unit task/purpose
<input type="checkbox"/>	Abort criteria
<input type="checkbox"/>	Other UAS units task/purpose
<input type="checkbox"/>	Other UAS units graphics posted on map
<input type="checkbox"/>	Army aviation/friendly scheme of maneuver
<input type="checkbox"/>	ROE
<input type="checkbox"/>	GCS/GCU and L/R site security
<input type="checkbox"/>	Additional UAS equipment necessary for 24-hour operations (if commander directed)
<input type="checkbox"/>	Evaluate all specified tasks from:
<input type="checkbox"/>	OPORD WARNOs FRAGOs
<input type="checkbox"/>	Verify ACO, ATO, SPINS requirements
<input type="checkbox"/>	ROZ/ROA locations/dimensions/frequency/call signs Artillery position area locations plotted Active routes/airspace control points (ACPs) plotted
<input type="checkbox"/>	Verify method of airspace control
<input type="checkbox"/>	Positive control measures Procedural control measures
<input type="checkbox"/>	Verify H-hour time
<input type="checkbox"/>	Spare UA procedures
<input type="checkbox"/>	Emergency procedures
<input type="checkbox"/>	Downed UA recovery plan
<input type="checkbox"/>	Weather (WX) decision time
Mission planning:	
<input type="checkbox"/>	Sensor selection (if not dual selectable)
<input type="checkbox"/>	EO and IR imagery payload for day/night operations

SAMPLE

Table A-1. UAS mission planning checklist

<i>UAS Mission Planning Checklist</i>	
	EO or IR (Raven only)
<input type="checkbox"/>	Map reconnaissance of mission area
<input type="checkbox"/>	Identify terrain that will interfere with LOS data link
<input type="checkbox"/>	NAIs
	Grids defining NAIs Heading and distance to NAI from launch point Heading and distance between NAIs
<input type="checkbox"/>	Identify/mark natural and manmade hazards to flight
	Local hazards Sectionals
<input type="checkbox"/>	Primary route (ingress and egress)
<input type="checkbox"/>	Alternate route (ingress and egress)
<input type="checkbox"/>	Threat plotted along route
<input type="checkbox"/>	Weather
	Clouds Precipitation Wind Visibility Temperature Illumination
<input type="checkbox"/>	Flight route outside threat engagement rings
<input type="checkbox"/>	Route time
<input type="checkbox"/>	Loiter time
<input type="checkbox"/>	Verify grids
<input type="checkbox"/>	Check all altitudes, azimuths, and distances
<input type="checkbox"/>	Times submitted to higher headquarters
<input type="checkbox"/>	Waypoint card printed
<input type="checkbox"/>	Air control points plotted on map
<input type="checkbox"/>	Primary/alternate routes plotted on map
<input type="checkbox"/>	Contingency actions
Fuel planning:	
<input type="checkbox"/>	Availability and on-hand stockage of AVGAS/MOGAS
<input type="checkbox"/>	Availability and on-hand stockage of batteries (Raven only)
	BB-390 BA-5590
<input type="checkbox"/>	Availability and on-hand stockage of ammunition
<input type="checkbox"/>	Estimated fuel burn rate
<input type="checkbox"/>	Estimated battery usage rate (Raven only)

SAMPLE

Table A-1. UAS mission planning checklist

UAS Mission Planning Checklist							
<input type="checkbox"/> Minimum fuel at departure <input type="checkbox"/> Bingo fuel							
Communication plan: <input type="checkbox"/> Flight operations <input type="checkbox"/> TOCs, command nets <input type="checkbox"/> Air battle net <input type="checkbox"/> Fire support coordinator (FSCoord) net <input type="checkbox"/> Administrative and Logistics Operations Center (ALOC) net <input type="checkbox"/> ATC (airfields, approach, and others) <input type="checkbox"/> ROZ/ROA <input type="checkbox"/> LOS characteristics of terrain (UA limits of operation based on LOS data link)							
	<table> <tr> <td>Hunter</td> <td>125 km (200 km with second Hunter as airborne relay)</td> </tr> <tr> <td>Shadow</td> <td>50 km</td> </tr> <tr> <td>Raven</td> <td>10 km</td> </tr> </table>	Hunter	125 km (200 km with second Hunter as airborne relay)	Shadow	50 km	Raven	10 km
Hunter	125 km (200 km with second Hunter as airborne relay)						
Shadow	50 km						
Raven	10 km						
<input type="checkbox"/> Contingency actions							
	<table> <tr> <td>Frequency compromise</td> </tr> <tr> <td>COMSEC compromise</td> </tr> <tr> <td>Emergency procedures for loss of signal</td> </tr> </table>	Frequency compromise	COMSEC compromise	Emergency procedures for loss of signal			
Frequency compromise							
COMSEC compromise							
Emergency procedures for loss of signal							
<input type="checkbox"/> Communication frequency bandwidth of UAS operation <input type="checkbox"/> Frequency management <input type="checkbox"/> OPSEC requirements <input type="checkbox"/> EW considerations to include friendly communication interference							
<input type="checkbox"/> Packet/card/map preparation <input type="checkbox"/> Enemy graphics <input type="checkbox"/> Friendly graphics <input type="checkbox"/> ROZ graphics <input type="checkbox"/> Flight routes <input type="checkbox"/> Crew card <input type="checkbox"/> Time flow <input type="checkbox"/> Mission sequence <input type="checkbox"/> Waypoint card <input type="checkbox"/> Rehearsal setup							

SAMPLE

UNIT PLANNING CONSIDERATIONS

A-2. The following section gives specific information for UAS units.

WARNING ORDER

A-3. Upon receipt of a WARNO, begin mission analysis and start the UAS unit mission planning process. The following planning considerations (table A-2) are necessary to develop the final mission plan.

Table A-2. Unit planning considerations

Planning Considerations	
	UAS availability
	Compliance with ACMs
	Weather
	Target location
	Collection requirements
	Threat
	Payload
	Fuel/battery requirements
	Altitude and speed
	Loiter times
	Crew manning
	UAS return home locations
	Emergency recovery options

MISSION PLANNING

A-4. Conduct mission and flight planning simultaneously. Consider the following and accomplish these tasks (table A-3).

Table A-3. Mission/flight planning considerations

Mission Flight/Planning Considerations	
	Route planning
	Primary route
	Alternate route
	Airspeeds for each leg
	Hazards
	No-fly airspace
	Adjacent airfields
	Identify high terrain en route which route will cross over (LOS issue)
	IFF
	Plot route on map
	Overlay
	Launch site
	Waypoints
	Altitude

Table A-3. Mission/flight planning considerations

Mission Flight/Planning Considerations	
	Recovery site
	ROZ/ROA
	Deconflict route with adjacent units
	Complete mission briefing form
	Risk assessment
	NOTAMs checked
	Signal operations instructions (SOI)/SPINS/communication card
	Weather
	Preflight inspection completed
	File flight plan

CREW MISSION BRIEFING

A-5. The UAS crew briefing (table A-4) provides a concise review of the mission parameters within which the crew must perform their mission. The briefing occurs after mission planning and before the launch of the UA. At this point, all questions related to the mission should have been answered or open issues mitigated to an acceptable level. The only remaining question posed during the mission brief is can the mission be accomplished as briefed or are deviations required? The crew clarifies the mission parameters specified in the order and seeks approval for any needed deviations.

Table A-4. Crew mission briefing considerations

Crew Mission Briefing Considerations	
	Mission: route reconnaissance, surveillance, other
	Mission type: tactical, training, other
	Conditions: day and (or) night
	Altitude(s)
	Speed(s)
	Payload
	Safety considerations
	Signal
	A2C2
	Weather
	NOTAMs
	Crew status
	Flight routes
	Crew comments and discussion
	Crew acknowledges briefing

CREW OR GROUND CONTROL SYSTEM CHANGEOVER

A-6. Brief a minimum of these items in case a crew change or GCS shift change is required (table A-5):

Table A-5. Crew or ground control system changeover briefing considerations

Crew or Ground Control System Changeover Briefing Considerations	
	Current situation - end states, current OPs, future OPs, (status boards)
	Challenge and password
	Major events that occurred
	Each individual Soldier, UA/payload operator, briefs respective highlights
	Communications status
	Current UA location/orientation
	Significant missions during shift
	Outstanding mission orders, other
	Status of personnel/equipment
	Last time generator was fueled

MISSION ORDER FORMAT

A-7. The mission order checklist (table A-6) gives a kneeboard-size briefing aid for the AMC and air battle manager.

Table A-6. Sample Mission Order Checklist

Mission Order Checklist	
<input type="checkbox"/> OPORD <input type="checkbox"/> WARNO <input type="checkbox"/> FRAGO No. () DATE/TIME:	
OPERATION NAME: OPERATION ORDER #.	
TASK ORGANIZATION: <i>As per DA 5484-R-E (conduct crew manifest)</i>	
SITUATION:	
ENEMY FORCES/ FRIENDLY FORCES: <i>As per daily situation report (SITREP)</i>	
WEATHER: <i>As per DD 175-1 or Local Wx Brief (Temp, Winds, Illumination, Precipitation)</i>	
MISSION:	
EXECUTION: <i>Restate overall reconnaissance objective (include success criteria)</i>	
SCHEME OF SUPPORT: <i>As per Advisory Mission Tasking and Collection Support Brief</i>	
INGRESS/EGRESS: <i>As per Flight Planning Card & Operational Graphics</i>	
SPECIFIC INSTRUCTIONS TO SUBORDINATE UNITS	
Launch Aircrew/Crew Chief:	TIMELINE
	Decision
	Commo Check:
Preflight acct #	Shelter Power-Up:
Mission Aircrew:	Presets:
	Preflight:
	Armaments Installed:
PVO=Route Plan/MPO=Collection Plan	Engine Start:

Table A-6. Sample Mission Order Checklist

Mission Order Checklist				
Air Battle Manager/Data Exploiter/UTE:		Takeoff:		
		Control Transfer:		
		On-Station:		
		1st time on target (TOT):		
Recovery Aircrew/Crew Chief: <i>Post flight acft #</i> <i>Preflight acft #</i>		Relief on Station:		
		End of Mission:		
		Debrief Time/Location:		
RAV:		Elev/MagDec/Incl:		
DATA REPORTING/RECORDING: <i>Who/Where/What Payload</i>				
TYPE OF LAUNCH: <i>Normal, Remote, Hand-Off, Mobile, etc</i>				
COORDINATING INSTRUCTIONS:				
ACM/SPINS/TAP: <i>Verify AO per ACO</i>				
RELEASE AUTHORITY FOR LETHAL PAYLOAD:				
ABORT CRITERIA?WARNING:		IAS:	Altitude:	Fuel:
Weather: <2000/3 Jettison Point:		Aircraft:	Msn: RH Point:	
RELIEF ON STATION: <i>Control Transfer Points, Time-hack</i>				
HOME/LOSS OF LINK (LOL) PLAN: <i>Seconds after LOL, Spiral (Yes or No), Auto Emer status</i>				
RH Altitude:		RH Airspeed:	RH Holding Altitude:	
Instrument meteorological conditions (IMC) RECOVERY: <i>As per tactical standing operating procedures (TACSOP) and aviation planning guide (APG) (Brief local area rules/deviations)</i>				
SERVICE SUPPORT: <i>Fuel on-board aircraft in accordance with (IAW)</i>			Bingo Fuel:	
Personnel recovery (PR)/downed aircraft recovery team (DART): <i>Primary/Alternate Recovery:</i>				
DART Ldr:		DART Location/Freq:		
COMMAND/SIGNAL:				
COMM CARD (<i>Verify Validity</i>)		Internal Freq:		
Downlink Frequency		Transponder Codes:		
Uplink Frequency		Laser Codes:		
RVT Frequency		Elev/MagDec/Incl:		
GCS/RVT Location (<i>if necessary</i>)				

RQ-11 RAVEN HANDOVER PROCEDURE

A-8. Units use the following handover procedure when transferring an UA and mission from one GCU (GCU A) to another (GCU B). Employ a handover procedure to—

- Allow Raven to fly beyond LOS (see figure A-1).
- Allow Raven to fly further than 10 kilometers.
- Launch and recover Raven in safe areas, but operated closer to a specific location.

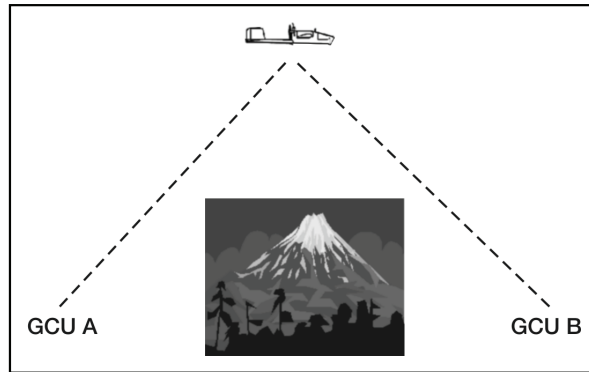

Figure A-1. Raven LOS handover

LIGHT PREPARATION

A-9. Preparations for GCU A and GCU B appear in table A-7.

Table A-7. Flight preparation for GCU handover

Both GCU A and GCU B
_____ Select time and location for handover procedure. _____ Select safe rally zone for aircraft recovery. GCU home location is not generally a good recovery coordinate.
GCU A
_____ Select home location where handover point is within Raven link range and LOS. _____ Set up system as normal at this location. _____ Power up aircraft and GCU. _____ Select rally point for loss-of-link at predetermined safe recovery area. _____ Set rally point altitude.
GCU B
_____ Select home location where handover point is within range and LOS. _____ Leave uplink and downlink antennae disconnected during assembly of GCU. _____ Power up GCU. _____ De-select "Autoland" on aircraft controller. _____ Unplug aircraft controller cable from controller (this turns off uplink transmitter). _____ Connect uplink antenna. _____ Manually input "Home" coordinates of GCU B. _____ Connect downlink antenna. _____ Select rally for loss-of-link. _____ Set rally coordinates to prearranged safe recovery area. _____ Set rally point altitude.

FLIGHT OPERATIONS

A-10. Follow the guidelines in table A-8 for the remainder of the handover procedure.

Table A-8. GCU handover procedures

GCU Handover Procedures	
GCU A	Perform pre-flight procedures as normal. Launch at a time that puts aircraft near handover location at pre-determined time. Fly aircraft to handover location.
GCU B	Watch mission controller as agreed handover time approaches. Video should be visible as aircraft approaches handover location.
GCU A	Upon reaching handover location, unplug aircraft controller cable. The mission controller screen will display "en route rally point" message.
GCU B	When mission controller displays "en route rally," connect aircraft controller. "Rally" message is signal that UA is ready to be controlled. Select desired flight mode and press ENTER. "Rally" message should cancel if GCU B has control. Verify control of aircraft.
GCU A	Cancellation of the "en route rally" message is a signal that GCU B has control of aircraft. If GCU B does not take command within several minutes, take control and repeat process.

OTHER CONSIDERATIONS

A-11. The following considerations are necessary when planning and executing handover procedures:

- Display of the "rally" message will not occur when downlink is not functioning.
- The first powering-up of the UA sets the home position of GCU A. If GCU B is near, the home position of GCU B may be set to "A" as well.
- Manual input of the home waypoint overwrites the existing home waypoint.
- If loss-of-link occurs before the aircraft reaches the designated handover position, GCU B may not be able to take control.
- When the aircraft reaches the rally point, it will autoland.
- Use of the operation procedure will pass the UA back to GCU A after the mission is complete.
- Compromise the mission at anytime and the aircraft can/will return to its safe landing rally zone.
- A good handover location is a waypoint.

Appendix B

Extract from Leader's Guide to Army Airspace Command and Control at Brigade and Below

This appendix is an extract from the leader's guide to A2C2 at brigade and below, Center for Army Lessons Learned (CALL) Handbook 05-25, dated June 2005. The handbook gives an overview of A2C2, including types of airspace control, modular design, and unit level duties and responsibilities. It also focuses on SUAS operations and A2C2. Finally, it discusses common SUAS airspace coordination techniques and procedures.

SECTION I—GENERAL

B-1. A2C2 is the Army's application of airspace control to coordinate airspace users for concurrent employment in assigned missions. Effective A2C2 enables the warfighter functions to operate efficiently while synchronizing air operations to support the commander's intent. Successful A2C2 is dependent upon the ability to perform the functions of identification, coordination, integration, and regulation of airspace users. A unit's proficiency in performing these functions correlates to its aptitude in C2, AD, FS coordination, ATC, and airspace management activities.

B-2. The term A2C2 does not denote Army ownership of a block of airspace or command over activities within that airspace. Rather, it refers to Army users of the airspace. All air missions are subject to the ACO published by the ACA. It provides direction to deconflict, coordinate, and integrate airspace within the operational area. Joint forces also use airspace to manage air operations, deliver fires, employ AD measures, and undertake intelligence operations. These missions may be time sensitive and preclude the ability to conduct detailed coordination with the land force. Land forces must provide their higher headquarters with all ACMs to provide visibility to other joint users and prevent fratricide.

B-3. Airspace control does not infringe on the authority vested in commanders to approve, disapprove, or deny combat operations. The primary objective of airspace control is to maximize the effectiveness of combat operations without adding undue restrictions and with minimal adverse impact on tactical operations (see FM 3-52).

Note: Because of the dynamic nature of both rotary wing and SUAS operations, the chain of command will establish and enforce A2C2 procedures.

WARNING

FAILURE TO CONDUCT AIRSPACE COORDINATION BEFORE SUAS OPERATIONS MAY CONTRIBUTE TO A MID-AIR COLLISION, RESULTING IN SEVERE INJURY OR DEATH TO PERSONNEL.

TYPES OF AIRSPACE CONTROL

B-4. Brigade operations require the commander to use airspace control to synchronize air and ground battlespace in support of maneuvers. Control of airspace users is by positive and procedural means, or a combination of both. Examples that combine both procedural and positive control measures are in section III of this appendix.

POSITIVE CONTROL

B-5. The conduct of positive control is by elements established by the ACA that positively identify, track, and direct air assets in the airspace control area. It uses electronic means such as radar; other sensors; IFF systems; selective identification feature capabilities; digital data links; and other elements of the command, control, communications, and computer systems. Normally, the BCT does not have the capability to provide positive control unless augmented with an air traffic services support package.

PROCEDURAL CONTROL

B-6. Procedural control relies on previously agreed to and disseminated ACMs. These may include ROEs, ROAs/ROZs, standard-use Army aircraft flight route (SAAFR), aircraft identification maneuvers, FSCMs, and coordinating altitudes. FM 3-52, chapter 4, describes different types of procedural control measures. Furthermore, it provides Army ACM SOPs, which aid in deconfliction.

B-7. Among the procedural ACMs, it is particularly important for leaders at brigade, battalion, company, and platoon level to understand the following.

Air Control Point

B-8. An airspace control point is an easily identified point on the terrain or an electronic navigational aid used to provide necessary control during air movement. It is typical to designate air control points at each point where the flight route or air corridor makes a definite change in any direction and at any other point deemed necessary for timing or control of operations. It is a graphic control measure used to segment an air corridor similar to checkpoints on a ground route.

Air Corridor

B-9. An air corridor is a restricted air route of travel specified for use by friendly aircraft and established for preventing friendly forces from accidentally firing on friendly aircraft. One use of air corridors is to route combat aviation elements between such areas as FARPs, holding areas, and BPs. These corridors also deconflict artillery-firing positions with aviation traffic, including UAS. Altitudes of an air corridor do not exceed the coordinating altitude.

Base Defense Zone

B-10. A base defense zone (BDZ) is an AD zone established around an air base and limited to the engagement envelope of short-range AD weapon systems defending that base (JP 3-52). BDZs have established entry, exit, and IFF procedures. Think of the BDZ as a specific type of ROA or special use airspace. Employment of counter-rocket, artillery, and mortar (C-RAM) capabilities at fixed sites or bases within a BCT's AO may necessitate the establishment of a BDZ.

Coordinating Altitude

B-11. Coordinating altitude is a procedural airspace control method used to separate fixed- and rotary-wing aircraft. This method determines an altitude below which fixed-wing normally will not fly and above

which rotary wing normally will not fly. The airspace control plan specifies the coordinating altitude and may include a buffer zone for small altitude deviations.

Restricted Operations Zone/Restricted Operations Area

B-12. ROZ/ROA is airspace of defined dimensions created in response to specific operational situations or requirements within which the operation of one or more airspace users is restricted. Establishing a ROZ helps prevent fratricide by closely restricting access over a designated surface area. Typical uses are over Army Tactical Missile System launch and target areas as well as UAS L/R areas. Depending upon the airspace control plan, a specific AOR may or may not be included on the ACO.

B-13. Established ROZ/ROAs can occur over areas where combat operations involving a mix of air vehicles are likely employed (such as over urban operations areas). The dissemination of ROZ/ROA information is throughout theater using the ACO. Information about the ROZ includes contact frequency for the aircraft desiring to transition through the ROZ.

B-14. The BCT responsible for the AO is also in charge of monitoring frequency and communicating with aircraft as required for the entire period the ROZ is active. Although the brigade TOC radio telephone operator (RTO) may be responsible for monitoring the frequency, the brigade FSE coordinates and tracks all fires and aviation activity in the ROZ/ROA. Refer to FM 3-52 for more information.

TYPES OF SEPARATION

B-15. There are three primary means of maintaining separation between manned and unmanned aircraft: lateral, time, and vertical separation. Beyond the need to ensure physical separation exists, leaders must plan for frequency separation between unmanned vehicles.

LATERAL SEPARATION

B-16. Lateral separation spaces aircraft operating at the same altitude by not having them operate in the same geographic space. The assignment of flight corridors, ROAs/ROZs, and other graphic control measures, such as phase lines and unit boundaries, are methods of ensuring lateral separation.

TIME SEPARATION

B-17. Time separation spaces aircraft operating in the same geographic area or at the same operating altitudes by not allowing them to operate at the same time. Time separation may also be required when aircraft, manned and unmanned, must fly near indirect fire trajectories or ordnance effects. The timing of surface fires must be coordinated with aircraft routing. This ensures that even though aircraft and surface fires may occupy the same space, they do not do so at the same time.

VERTICAL SEPARATION

B-18. Vertical separation spaces aircraft based on operating altitude or assigning different operating altitudes to UA working in the same geographic area. Vertical separation is the least preferred method because SUAS and rotary wing aircraft normally operate from the surface to 500 feet AGL.

ARMY AIRSPACE COMMAND AND CONTROL UNDER THE MODULAR DESIGN

B-19. In the modular force airspace management occurs in A2C2 cells, organic to units from the BCT through the corps. These cells combine aviation and ADA personnel who operate in close coordination with the unit's FEC or fires cell. Fires and airspace deconfliction in the FEC at the BCT level is closely coordinated between the targeting officer, ALO, ECOORD and the air defense airspace management (ADAM)/BAE cell. The FEC and the ADAM/BAE cells should be side by side in the BCT CP to facilitate rapid coordination.

B-20. These A2C2 cells from the BCT through corps have full digital connectivity to the theater level, enabling the BCT to request airspace digitally. This digital connectivity should drastically reduce the processing and staffing time associated with airspace requests. The Tactical Airspace Integration System (TAIS) is the component of the ABCS for automating and integrating airspace management at the BCT and above.

B-21. For units not yet transitioned into the modular force, commanders must assign these critical duties and responsibilities of airspace coordination to someone within their organization (usually a member of the S3 staff).

B-22. The following section provides examples of other methods available and uses for non-TAIS equipped organizations. It also discusses alternatives to when TAIS digital connectivity does not exist. Battalion A2C2 tasks are listed in paragraph E-29 below.

BRIGADE ARMY AIRSPACE COMMAND AND CONTROL ORGANIZATION

Brigade Combat Team

B-23. BCTs have an ADAM/BAE to manage the function of airspace management. The ADAM/BAE is a cell that combines air and missile defense and aviation personnel along with enhanced digital capabilities to provide the BCT with a capability to perform A2C2 and maintain a NRT airspace picture. The ADAM/BAE coordinates A2C2 requirements with higher headquarters and may be required to coordinate with joint or multi-national forces to integrate the BCT requirements into the operations.

B-24. The BAO is the lead integrator among the brigade staff members responsible for A2C2 tasks. The primary duty of the BAO is to integrate aviation into the scheme of maneuver. The BAO accomplishes this by close coordination with the S3 and BCT commander. The BAO works for the BCT commander and is an integral part of his staff. He must also maintain a relationship with the aviation brigade commander and his staff. The BAO must ensure exchange of appropriate information between the aviation brigade, BCT, and remainder of the BAE to facilitate smooth and timely aviation support.

B-25. Within the ADAM/BAE, the BAE supports the BCT commander by planning and synchronizing Army aviation operations and conducting A2C2 throughout the BCT AOR. Paired to this effort, the ADAM provides the BCT commander with a joint capability. It can link with an air picture provider, (joint or local) to detect aircraft as they become airborne, assign them a friendly identification, and transmit the track information and identification to reduce the chance of fratricide. The ADAM cell air defense coordinating officer is in charge of air missile defense operations within the ADAM/BAE and provides SA, SU, and early warning for the brigade.

B-26. The ADAM/BAE implements and disseminates the ACO for brigade and below, and the FEC provides the same function for the ATO. The BAE is responsible for the integration and synchronization of the ACO/ATO, Army aviation and UAS, and submits an airspace control means request to the next higher A2C2 element. When the BCT works directly for a JTF, the ADAM/BAE is capable of interfacing directly with the battlefield coordination detachment (BCD) (the Army's liaison at the Air Operations Center).

Other Brigades

B-27. The ADAM/BAE is a standardized organization that exists in the heavy and light BCTs. A similar organization, the ADAM cell, exists in the SBCT with a smaller aviation element. Variants of the ADAM/BAE also exist in other brigades such as the battlefield surveillance brigade (BFSB), fires brigade, and aviation brigade. While the structure may be different from the ADAM/BAE in the BCT, the functions and responsibilities remain the same.

BATTALION AND BELOW ARMY AIRSPACE COMMAND AND CONTROL ORGANIZATIONS

B-28. Battalion and below have no formal A2C2 element. The battalion S3 has overall responsibility for coordinating, deconflicting, and managing airspace within the battalion AO. The ADAM/BAE at the BCT minimizes the A2C2 workload on battalion/company/platoon SUAS operators. Battalions must coordinate with the ADAM/BAE at the BCT to ensure the processing of their mission requests as efficiently and expeditiously as possible.

B-29. Battalion A2C2 tasks include—

- Establish S3 Air or equivalent, from existing personnel assigned to the S3 section, which has staff responsibility for all SUAS operations.
- Receive and disseminate SUAS airspace request approvals, changes, and disapprovals.
- Review planned and immediate airspace requests and resolve conflicts within the battalion.
- Monitor and analyze aviation, SUAS FA, AD, and maneuver operations to determine and resolve conflicts.
- Submit to ADAM/BAE all planned and immediate airspace requests including SUAS (see section VII of this appendix).
- Communicate any deviations from preplanned mission to the ADAM/BAE or higher headquarters immediately.
- Ensure no SUAS flies without prior airspace coordination through the ADAM/BAE or higher headquarters.
- Inform airspace users at each echelon of any communication loss during operations.
- Track and report aviation, FA, AD, and SUAS systems and personnel status.
- Monitor rotary/fixed wing aircraft in the battalion AOR to aid in deconflicting SUAS and other air traffic.
- Manage separation and frequencies of battalion and below UAS operations.

SMALL UNMANNED AIRCRAFT SYSTEM MISSION REQUEST FORMAT

B-30. There are two types of mission requests, planned and immediate. Further, there are two formats for requesting planned missions and one format for an immediate mission. Examples of mission requests are located in section VII. The battalion will consolidate and deconflict subordinate mission requests and send to the ADAM/BAE at the BCT. The ADAM/BAE will extract the pertinent information for airspace management. If using the TAIS to deconflict airspace, the ADAM/BAE will enter the data into the TAIS workstation. Mission requests can be sent by radio (SINCGARS, VHF, UHF), advanced mobile phone system, Force XXI battle command brigade and below (FBCB2), TAIS web page for airspace control means requests and tracking (WebACMR), or BFT.

MISSION APPROVAL FLOW GUIDE

B-31. The ADAM/BAE, representing the brigade commander/S3, has the responsibility to deconflict air missions between battalions. Conflicts may result in mission modifications or cancellation dependant upon mission priority.

B-32. ABCS provides a means for rapid deconfliction and the ability to share digital airspace information quickly between units and higher echelons. Because the ADAM/BAE will have visibility of airspace requests across the network, most deconfliction will be at the brigade level.

B-33. For nonmodular forces or forces lacking digital connectivity, the mission approval flow remains the same, but the systems used and personnel executing specific responsibilities will be different. The S3/G3 and S3/G3 Air carry out the roles and responsibilities of the ADAM/BAE/division A2C2 cell. While TAIS is the primary intended means for managing airspace, other methods are available and used for non-TAIS equipped organizations or when TAIS digital connectivity does not exist. An example of another method

would be to import a created FalconView screen capture into a PowerPoint slide. See section VII of this appendix for example format and detailed information.

SMALL UNMANNED AIRCRAFT SYSTEM MISSION PLANNING FLOW

B-34. Battalion commander, S3, S2, fire support officer (FSO), or company commander determines a need for SUAS mission.

B-35. Battalion S3 (or S3 Air if assigned) ensures no internal battalion conflict with other internal SUAS operations and known airspace users (aircraft, CAS, fires, C-RAM, and others) and passes initial mission data to the supporting company to begin planning. The company, with assistance from the SUAS MC, creates a detailed flight plan that includes specific routes, times, and locations. The battalion S3 also submits a mission request up to the BCT's ADAM/BAE (see section VII of this appendix).

B-36. If the ADAM/BAE receives the request by voice or text, they enter the pertinent airspace data into the TAIS. Automatic entry of data into the TAIS occurs when the received data is via WebACMR. The ADAM/BAE reviews the mission request to determine any airspace conflicts between the SUAS and other airspace users in the brigade AO.

- Because most SUAS missions fly below the coordinating altitude, the focus for deconfliction will be with Army aviation or CAS weapons effects.
- Theater-specific directives will determine mission request approval authority. In OIF, approval authority resides at the division.
- When employing C-RAM capabilities in the brigade AOR, a BDZ or similar ACM may impose certain additional deconfliction or coordination requirements on UAS operations, including coordination with any C-RAM unit operating at intended SUAS launch/recovery sites.

B-37. If a conflict exists, the ADAM/BAE determines mission priority based upon the commander's guidance and makes recommendations to the brigade airspace approval authority (brigade S3 or brigade commander). Upon COA approval, the ADAM/BAE notifies the affected battalion S3/S3 Air and provides recommended modifications to support mission request if possible.

- Battalion S3/S3 Air accepts modifications or provides an alternative COA.
- The ADAM/BAE then updates the modified/alternate mission data with higher headquarters.

B-38. The ADAM/BAE deconflicts the mission request and forwards to higher headquarters A2C2 cell and G3 aviation cell (usually the division).

- As the company further refines the mission details, it sends the updated data to the battalion S3/S3 Air, who in turn forwards it to the ADAM/BAE.
- The ADAM/BAE adds any additional details/modifications to the mission request, which is now potentially visible at every brigade and above level A2C2 cell in theater.

B-39. The division A2C2 cell forwards the approved mission request to higher A2C2 cells and all subordinate BCTs and support brigades (such as fires brigade, maneuver enhancement brigade, BFSB, and aviation brigade) for coordination and safety purposes. If the approval authority is division or higher, the mission request will be approved when deconflicted.

- If the mission request conflicts with other missions, division A2C2 cell determines mission priority based upon the commander's guidance and makes recommendations to the airspace approval authority (usually the division G3).
- Once the airspace approval authority approves a COA, the division A2C2 cell notifies the affected BCT ADAM/BAE cell of the conflict and provides recommended modifications to support the mission request.

- The ADAM/BAE deconflicts the mission with appropriate requesting organization.
- ADAM/BAE sends modified approved mission request back to division A2C2 cell for deconfliction/approval/SA (approving authority dependent), simultaneously updating and modifying previously submitted mission requests.

B-40. Division deconflicts the mission request across the entire division force and forwards the mission request to the higher headquarters in accordance with theater-specific procedures if further deconfliction is required.

SECTION II—SMALL UNMANNED AIRCRAFT SYSTEM OPERATIONS

SMALL UNMANNED AIRCRAFT SYSTEM PLANNING AND MISSION EXECUTION

B-41. The mission of the SUAS is to provide RSTA, day/night imagery to support SA, and BDA. The SUAS operates from platoon to battalion level and is suited for rapid employment to meet the needs of the commander.

AIRSPACE MANAGEMENT FOR SMALL UNMANNED AIRCRAFT SYSTEMS

B-42. Use of airspace control procedures is necessary to ensure the safe employment of SUAS in conjunction with fixed- and rotary-wing aircraft, other UAS, friendly AD fires, and indirect fires in the division airspace. Each unit has unique airspace challenges based on its AO (civilian airports, controlled airspace, urban operations, and others) and mission set (TTP for employment of air and fires assets). Because of these distinct differences in AOs, SUAS planners must know and comply with the established airspace procedures and applicable AOR aviator planning guide to prevent loss of life and (or) damage to equipment.

B-43. SUAS flights must be coordinated to ensure deconfliction with other airspace users. The primary means for ensuring SUAS are deconflicted with all other airspace users is through the ADAM/BAE at the brigade. The ADAM/BAE serves as the “one stop shop” in the modular force for airspace deconfliction at the BCT level. The ADAM/BAE deconflicts all airspace missions within the brigade and informs higher headquarters to ensure deconfliction occurs with units above the brigade level when necessary. The ADAM/BAE will coordinate among battalions, through higher headquarters, to separate SUAS safely from manned aircraft and to prevent engagement by friendly AD systems.

B-44. The ACA may use the coordinating altitude to separate fixed wing traffic from SUAS traffic in the same manner it sometimes uses the coordinating altitude to separate fixed wing traffic from rotary wing traffic. When this happens, the approval authority for most SUAS missions will reside at either division or, possibly, brigade level and mission requests will be sent higher for SA.

PREPLANNED SMALL UNMANNED AIRCRAFT SYSTEM OPERATIONS

B-45. When possible, preplanned SUAS flights should appear on the ACO, allowing for advanced notice of SUAS operations to manned rotary wing aircraft. Identify and request airspace requirements through airspace management channels (ADAM/BAE) during planning to ensure deconfliction. When approval authority resides below the JFACC, these missions usually will not appear on ATO/ACO if the SUAS operating altitude remains below the coordinating altitude. Instead, the division may manage a separate list or matrix of missions below the coordinating altitude that nevertheless must be deconflicted and receive approval internal to the division.

B-46. Section VII contains the mission request format. Personnel must submit the request as soon as possible to the ADAM/BAE for deconfliction.

IMMEDIATE SMALL UNMANNED AIRCRAFT SYSTEM OPERATIONS

B-47. SUAS missions are conducted with limited or no prior planning. Despite being time sensitive, airspace coordination must still occur. It is incumbent upon units at all levels to develop battle drills to expedite planning, A2C2, and mission execution. Immediate SUAS missions will be coordinated with the appropriate airspace control agencies (the ADAM/BAE at the BCT) to separate SUAS safely from manned aircraft and to prevent inadvertent engagement by friendly AD elements.

B-48. At a minimum, submit the immediate mission request (complete all seven lines) to the ADAM/BAE. The ADAM/BAE will inform the requestor when granted launch permission, including the broadcast of a UAS launch alert to notify all BCT airspace users.

B-49. The immediate mission request format is—

- Line 1: Unit identification (call sign and frequency).
- Line 2: L/R site.
- Line 3: ROA location (includes GPS coordinates and operating altitude).
- Line 4: Ingress route, azimuth and distance.
- Line 5: Egress route, azimuth and distance.
- Line 6: Times and durations of mission.
- Line 7: SUAS operating channel.

SECTION III—COMMON SMALL UNMANNED AIRCRAFT SYSTEM AIRSPACE COORDINATION TECHNIQUES AND PROCEDURES

TYPES OF PROCEDURAL AIRSPACE CONTROL

SMALL UNMANNED AIRCRAFT SYSTEM OPERATIONS WITHIN VICINITY OF FORWARD OPERATING BASE

B-50. This procedure (figure B-1) involves two basic principles. They include preestablishment of ROAs and operating only within approved/active ROAs.

- Preestablish ROAs around the FOB over key areas to facilitate rapid launch of SUAS as part of a quick reaction force (QRF).
- Battalion S3 submits SUAS mission request to ADAM/BAE cell.
- If a battalion FOB, the battalion S3/FSO will manage the airspace.
- Operators call TOC, obtain clearance from S3/FSO before launching SUAS, and remain in radio contact during entire mission.
- Advise the higher headquarters of SUAS launch for quick reaction missions.
- TOC deconflicts airspace with rotary wing aircraft.

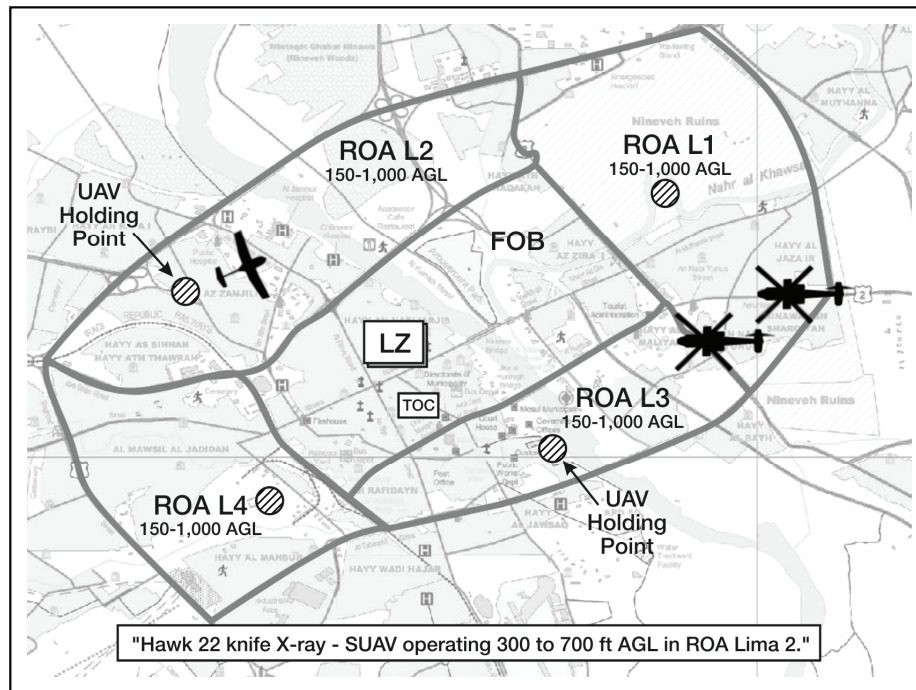

Figure B-1. SUAS operations within vicinity of FOB

SMALL UNMANNED AIRCRAFT SYSTEM OPERATIONS WITHIN BRIGADE COMBAT TEAM AREA OF RESPONSIBILITY

B-51. SUAS operations within a BCT AOR (figure B-2) follow the principles of a preplanned or immediate mission.

- SUAS operators request to establish a ROA (within the AOR) to support the mission.
- Airspace controlling agency establishes ROA and disseminates to rotary wing units operating in AOR.
- Notify rotary wing assets requesting to transition through AOR of ongoing SUAS operations on the brigade/battalion TOC net.
- SUAS operators contact battalion TOC before launch.
- Battalion TOC notifies higher headquarters TOC.
- SUAS operators maintain radio/digital contact during entire mission with airspace controlling agency of AOR.

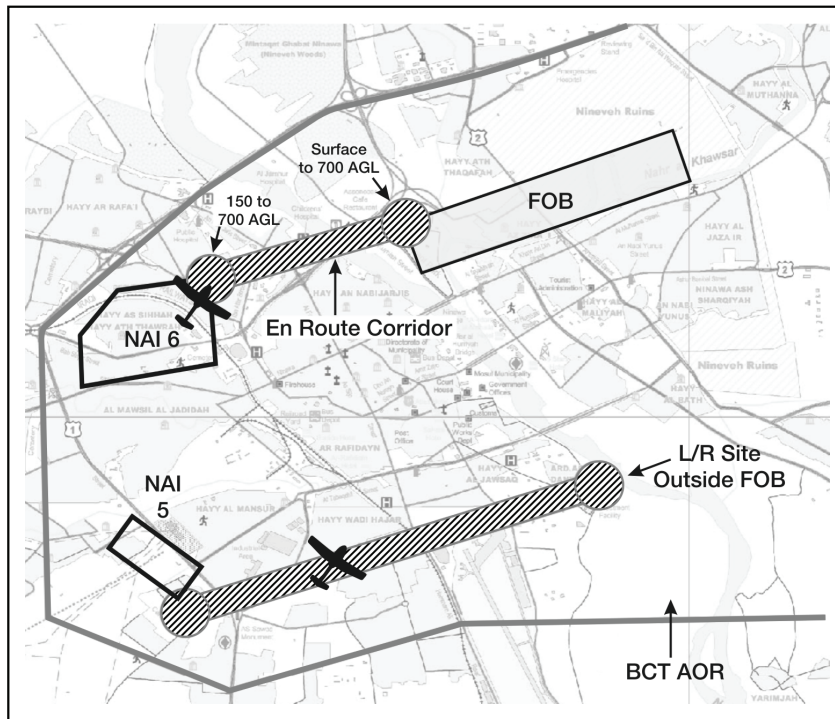

Figure B-2. SUAS operations within BCT AOR

SMALL UNMANNED AIRCRAFT SYSTEM OPERATIONS VICINITY AIRFIELD/AIRPORT

B-52. When a SUAS mission is performed in the vicinity of an airfield (within controlled airspace), the tower controls the airspace and is responsible for deconfliction. The following principles are used (figure B-3). SUAS operators (or staff representatives)—

- Conduct coordination with tower and establish procedures for SUAS operations within the controlled airspace.
- Establish means of two-way communications with tower.
- Submit mission plan in advance if possible.
- Request permission to launch and recover the SUAS.
- Maintain positive communications with the control tower during SUAS operations in the controlled airspace.
- Take commands from the tower during operations, as required, to allow other traffic to move through ROA.
- Call tower and close the ROA upon mission completion.

B-53. This example does not circumvent the normal planning sequence, but because the operation occurs within controlled airspace, the SUAS operator must coordinate and communicate directly with the airspace controller during execution of the mission.

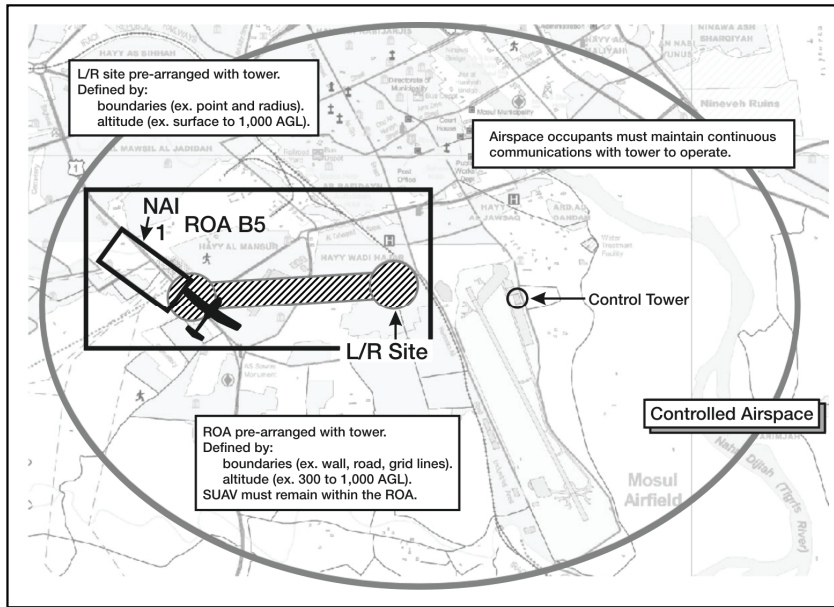

Figure B-3. SUAS operations vicinity airfield/airport

SMALL UNMANNED AIRCRAFT SYSTEM OPERATIONS OUTSIDE BRIGADE COMBAT TEAM AREA OF RESPONSIBILITY

B-54. Mission is required for convoy security or route reconnaissance operations when operating outside the BCT AOR (for example, convoy/route recon/IED sweep) (figure B-4). This is for use in noncontiguous operations, where SUAS operates between BCTs' AORs in areas controlled by division.

B-55. SUAS operators request in advance (through battalion and BCT) to establish a ROA to support the mission.

B-56. Use of an air route, with multiple ACPs, is also a suitable form of airspace control for these types of missions.

B-57. If a SAAFR already exists, use this route if possible. To prevent activation of the entire route, battalion notifies the ADAM/BAE to activate segments as the convoy moves, freeing the remainder of the SAAFR for other airspace users.

B-58. ADAM/BAE submits request through division for coordination.

B-59. SUAS operator maintains communications with higher headquarters or airspace controlling agency during entire mission.

B-60. Common procedures also established to separate SUAS from other aircraft.

B-61. Battalion communicates with rotary wing aircraft, as required, to facilitate traffic avoidance.

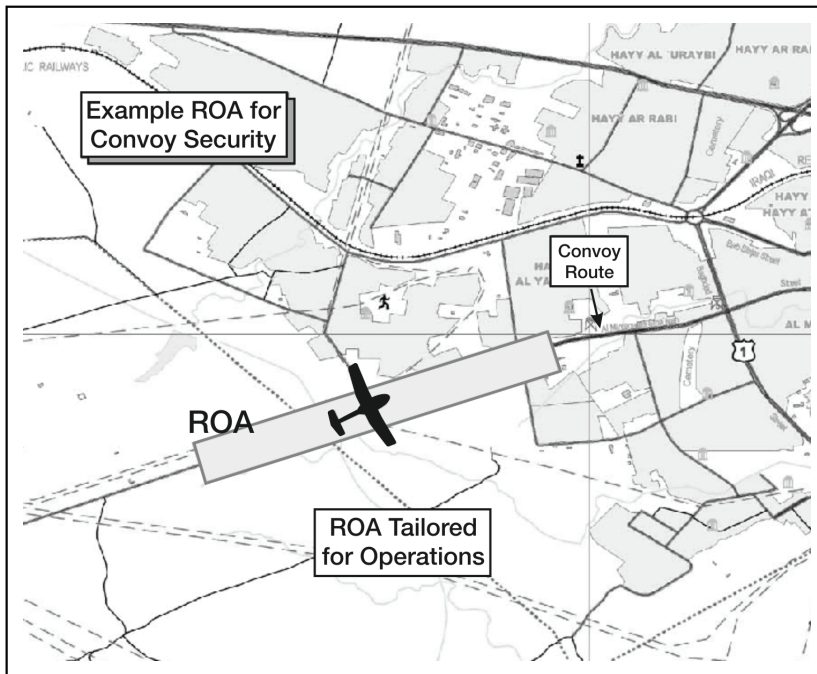

Figure B-4. SUAS operations outside BCT AOR

SMALL UNMANNED AIRCRAFT SYSTEM HIGH DENSITY URBAN OPERATIONS

- B-62. The area has a high volume of rotary wing/fixed wing and UA traffic (figure B-5).
- B-63. Segmenting a high-density urban area into zones is for ease of procedural control and management by an airspace control agency (for example, Baghdad Radio).
- B-64. Two-way communications are required for all participants.
- B-65. SUAS operators submit mission request using standard request procedures (including L/R point and mission ACPs).
- B-66. After mission approval from battalion, SUAS operators call the airspace control agency before launch and maintain positive communications during operation.
- B-67. SUAS operators must request permission from the airspace control agency before movement between ACPs or zones and (or) before descending below transit altitude.

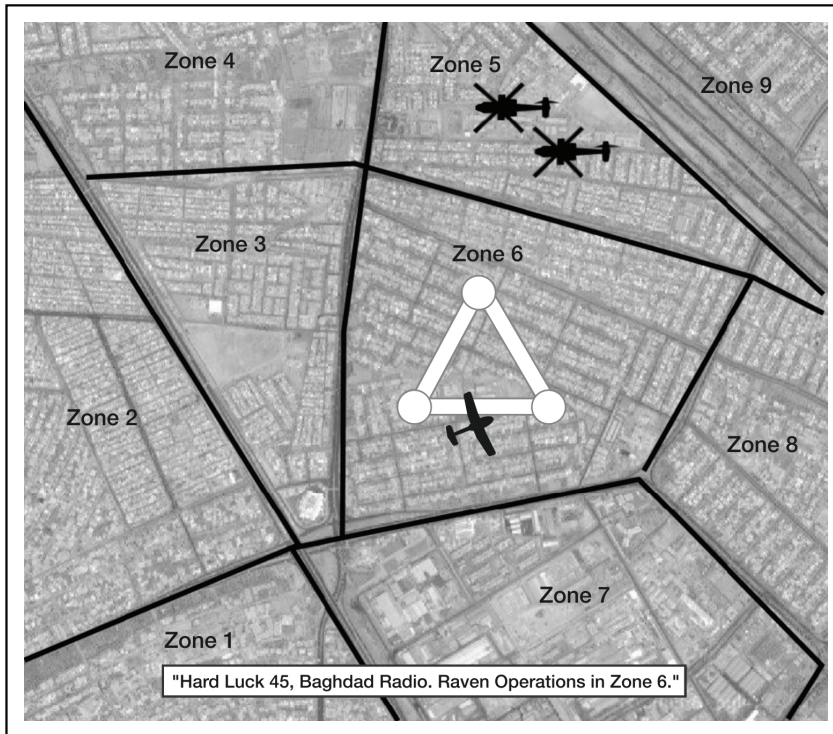

Figure B-5. SUAS high density urban operations

SECTION IV—LOSS OF LINK RECOVERY OPERATIONS

B-68. Loss of link is a function of no uplink from the GCU to the air vehicle, no downlink from the air vehicle to the GCU, or both. When this loss of link occurs, the UA will initiate the planned program placed into the GCU (such as rally to a predetermined point or land as soon as detecting a loss of link). Failure to prepare adequately for loss of link may result in loss of air vehicle. If link quality degrades to the point where the operator no longer has control of the air vehicle, the operator must do the following:

- Immediately notify higher airspace controlling agency (for example, FEC, combat control team of UA loss of link to include last known position, heading, airspeed, and altitude.
- Continue attempts to regain control of the UA, including commanding “autoland.”
- Assess the situation (proximity of other aircraft, restricted airspace, and others) and report possible entry of the air vehicle into any known hazards.

B-69. Upon notification of an uncontrolled UA by the operator, the ADAM/BAE or airspace control agency (tower, Baghdad Radio, FOB TOC) will broadcast an advisory on appropriate frequencies to notify any other airspace users of the errant UA.

SECTION V—MISSION FLOW GUIDE

B-70. Provided below is a mission flow guide (figure B-6):

- SUAS mission requirement determined.
- Mission planning at appropriate levels begins.

Appendix B

- Mission request submitted from battalion to ADAM/BAE.
- ADAM/BAE reviews mission request for conflicts.
- If approved, the ADAM/BAE notifies battalion S3 and forwards to next higher-level approval authority.
- If there is a conflict, ADAM/BAE—
 - Makes recommendations to the airspace approval authority.
 - Notifies battalion S3 along with recommended modifications.
 - Battalion S3/S3 Air accepts or provides an alternative.
 - The ADAM/BAE updates the mission.
- Forward a mission request to the next higher A2C2 cell (usually the division).
- Continually forward mission refinements for update.

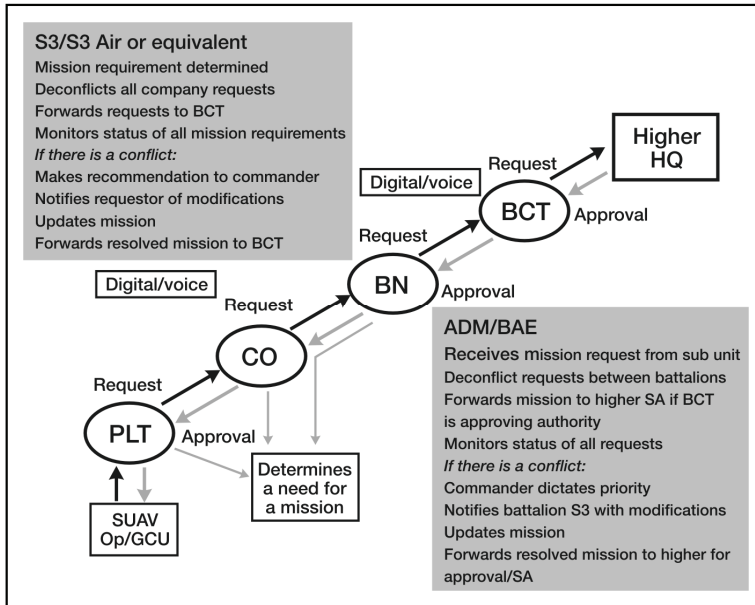

Figure B-6. Mission flow guide

SECTION VI—SMALL UNMANNED AIRCRAFT SYSTEM TROOP LEADING PROCEDURES CHECKLIST

B-71. Provided below is a troop leading procedures (TLP) checklist (table B-1):

Table B-1. SUAS TLP checklist

SUAS TLP Checklist
<p>RECEIVE THE MISSION</p> <ul style="list-style-type: none"> <input type="checkbox"/> Identify PIR, specific NAIs. <input type="checkbox"/> Time of mission execution. <input type="checkbox"/> Get target approval from battalion. <input type="checkbox"/> Request weather forecast from S2. <p>ISSUE WARNO</p> <ul style="list-style-type: none"> <input type="checkbox"/> Charge/confirm charge of aircraft/video recorder batteries. <input type="checkbox"/> Prepare aircraft (two aircraft if available or as per SOP), GCU and RVT. <input type="checkbox"/> Precombat inspection (PCI) equipment list. <ul style="list-style-type: none"> <input type="checkbox"/> Binoculars. <input type="checkbox"/> Hand held GPS. <input type="checkbox"/> Map. <input type="checkbox"/> Charged batteries (GCU and UA). <input type="checkbox"/> Battery charger and generator or power source. <input type="checkbox"/> Compass. <input type="checkbox"/> Repair kit with tape. <input type="checkbox"/> Flashlight and chemlights. <input type="checkbox"/> Recording device. <input type="checkbox"/> Flight logs. <input type="checkbox"/> SUAS operators manual. <input type="checkbox"/> Notebook. <input type="checkbox"/> Wind meter. <p>MAKE A TENTATIVE PLAN</p> <ul style="list-style-type: none"> <input type="checkbox"/> Refer to SUAS operator's manual for planning considerations. <input type="checkbox"/> Initiate the mission planning process with consideration given to— <ul style="list-style-type: none"> <input type="checkbox"/> Aircraft availability. <input type="checkbox"/> Location and compliance with ACMs (ROZ/ROA and others). <input type="checkbox"/> Weather. <input type="checkbox"/> Target location. <input type="checkbox"/> Collection requirements. <input type="checkbox"/> Threat. <input type="checkbox"/> Battery requirements. <input type="checkbox"/> Altitude and speed. <input type="checkbox"/> Loiter times. <input type="checkbox"/> Crew manning. <input type="checkbox"/> UA return home locations. <input type="checkbox"/> Emergency recovery options. <input type="checkbox"/> Plot target and mission (utilize PFPS/FalconView if available). <input type="checkbox"/> Conduct LOS analysis using digital terrain elevation data (DTED) and planned flight altitudes. <input type="checkbox"/> Print graphics of specific NAIs. <input type="checkbox"/> Determine launch site.

Table B-1. SUAS TLP checklist

SUAS TLP Checklist
INITIATE MOVEMENT
<input type="checkbox"/> Prepare all equipment for mission.
CONDUCT RECONNAISSANCE
<input type="checkbox"/> Recon launch site.
<input type="checkbox"/> Conduct map/imagery recon of objectives.
COMPLETE THE PLAN
<input type="checkbox"/> Utilize the mission request format found in section VII.
<input type="checkbox"/> Plan flight route on PFPS/FalconView (ACMs, mission graphics, and others).
<input type="checkbox"/> Program AGL altitudes for entire flight on PFPS/FalconView.
<input type="checkbox"/> Submit the mission request. (section VII).
<input type="checkbox"/> Upon mission request approval, proceed with the mission.
ISSUE THE ORDER
<input type="checkbox"/> Conduct the SUAS mission team briefing.
SUPERVISE
<input type="checkbox"/> Verify grids.
<input type="checkbox"/> Sanity check all altitudes, azimuths and distances.
<input type="checkbox"/> Triple check to ensure all equipment is loaded and inspections are completed.
CONDUCT INSPECTIONS
<input type="checkbox"/> Perform PCI on vehicles.
<input type="checkbox"/> Load radios, conduct communication checks.
<input type="checkbox"/> Ensure all radios loaded with current COMSEC and tuned to appropriate frequencies.
<input type="checkbox"/> Setup RVT antenna and link to TOC.
<input type="checkbox"/> Ensure mission essential equipment on hand.
CONDUCT REHEARSALS

SECTION VII—MISSION REQUEST FORMAT

B-72. The following mission request format (table B-2) example is the preferred method:

<p>Call Sign: Lizard 13 Frequency: Channel 3 Control Radio: 56.275 PT Bde Cmd F123 Bn Cmd F234 Co Cmd F345 Plt F456 Launch Site: Same as Launch Recovery Site: Same as Launch Ground Altitude: 112 ft MSL Zone(s): 22 Mission Altitude: SFC-500 ft AGL Mission Time (L): 0100-0400 Waypoints: H - WX 12345 67890 A - WX 23456 78901 B - WX 34567 89012 C - WX 45678 90123 D - WX 56789 01234 E - WX 67890 12345</p>	
<p>Situation: Enemy attempting to smuggle weapons into sector from the Platte River. Mission: ID enemy boat ramps, smuggling points and trails to/from the river.</p>	

Table B-2. Mission request format (preferred method)

B-73. See paragraph B-49 for the immediate mission request format.

This page intentionally left blank.

Training Considerations

SECTION I—STANDARDIZATION

C-1. Standardization is in its infancy in unmanned aviation when compared to the manned systems owing to the rapid fielding of systems, which outpaced development of safety and standardization programs. Adherence to rules, regulations, and accepted procedures by operators and maintainers are mandatory. This protects Soldiers and systems by leading to enhanced capability and individual and unit performance. Currently, demonstrated skill and experience is the basis for selection of UAS IP candidates. Additionally, IP candidates receive instruction on implementation of the aircrew training program (ATP). This instruction includes a review of Training Circular (TC) 1-210, TC 34-212, and AR 95-23. A formal IP course was established in fiscal year 2005. The academics involved reflect much of the same material taught in manned aircraft IP courses.

C-2. At the unit level, the UAS commander appoints the unit SP and IP. The UAS operators maintain individual flight records folders (IFRFs) and individual aircrew training folders similar to the manned community and use DA Forms 7120-R (Commander's Task List), 7122-R Crew (Member Training Record), and 4507-R (Crew Member Grade Slip). UAS units do not have an organic flight operations section. This leaves maintenance of IFRFs to the unit's IP. Unlike manned systems, UAS units do not have the benefit of years of institutional knowledge and experience in properly maintaining these aviation unique forms and records. Staff can overcome this obstacle if the installation flight operations section provides assistance. UAS unit SP or IP should seek out manned aviation units and confer with that unit's SP or IP in the development and maintenance of ATPs.

RESPONSIBILITIES

C-3. The Directorate of Evaluation and Standardization (DES), in conjunction with the program manager (PM) UAS, sends a team to monitor and assist in the training of unit IPs and provide subject matter expertise to lay a solid foundation for a successful standardization program. One key to a successful program is a knowledgeable and supportive chain of command. Training and familiarization of ATPs at all levels of UAS command is required, including training at the service schools for UAS commanders. The interim solution is for DES to provide familiarization training and assistance to UAS commanders.

COMMANDER

C-4. The commander is the primary training manager for the unit's UAS training program. The commander bases training on the unit's wartime mission, maintains standards, and evaluates proficiency. The commander also provides required resources, and develops and executes training plans that result in proficient individuals, leaders, and units. Subordinate leaders (officers and NCOs), staff officers, SPs, IPs, and unit trainers (UTs) help the commander plan and prepare UAS training.

STANDARDIZATION OFFICER

C-5. The standardization officer (150U) is the commander's technical advisor on aircrew training and has technical supervision of the unit's aviation standardization program. The standardization officer develops, integrates, implements, monitors, and manages the UAS training and standardization programs for all rated and nonrated crewmembers. The commander may authorize the standardization officer to instruct and evaluate the crew from a crew or noncrew flight position based on the individual's qualifications.

C-6. In the absence of an established and mature standardization chain, the standardization office fills many of the same roles as the company or battalion standardization officer. The check and balance established through the standardization officer and SP relationship is vital to UAS units outside of the aviation organization.

STANDARDIZATION INSTRUCTOR PILOT

C-7. SPs train, evaluate and lead UAS-rated and nonrated crewmembers, evaluators/trainers, and IPs and UTs. The UAS SP assists with the supervision and maintenance of the standardization program. He also advises, as required, on the crew selection process and employment of UAS sensors and weapons. The SP acts as the coordinator for the standardization of reading files and individual Soldier training records.

INSTRUCTOR PILOT

C-8. During tactical operations, the IP recommends appropriate TTP for each mission. Additionally, they advise on the employment of UAS sensors and weapons. The IP will be familiar with and assist in the maintenance of reading files and Soldier training records.

UNIT TRAINER

C-9. UTs are Soldiers designated as specialized training instructors. They assist in unit training programs and achieve established training goals. A UT will instruct Soldiers in all UAS related topics and tasks, as they pertain to the assigned system.

SOLDIER RESPONSIBILITIES

C-10. Each Soldier is responsible for performing individual tasks the first-line supervisor identifies based on the unit's METL. The Soldier must perform the task to the standards listed in STP 34-96U14-SM-TG. In the event the Soldier has questions about how or which tasks to perform, the Soldier must ask the first-line supervisor for clarification. The first-line supervisor should know how to perform each task or be able to direct the Soldier to the appropriate training materials.

TRAINING

C-11. The key to successful training is to assemble the required elements and to train to standard (combined arms training strategies, MTPs, ATMs, and Soldiers' manuals), beginning at home station and extending to all operations. Critical to effective training are opposing forces (OPFOR), observer controllers, feedback from higher and adjacent headquarters, and a supported headquarters for air-ground integration.

C-12. Available institutional mission simulators and embedded simulation systems will improve sustainment training for practicing flight operations. The system simulates specific UA and payload parameters, allowing instructors to introduce system faults and errors and support training during all flight control modes, including automated landing.

C-13. UAS simulation is a primary mechanism for training operator procedures. When simulators are not available, the unit must develop alternatives that include range airspace and other areas cleared by civilian and military ATC. Elements are assembled and trained to represent supporting, supported, and higher headquarters elements (usually called white cells). Trainers organize vehicles from other units to replicate OPFOR target arrays. If the AD battalion is available, they can augment the OPFOR.

C-14. For GCS operators and their equipment task organized or assigned to non-UAS units, the owning unit has the responsibility for ensuring UAS operators maintain their proficiency within their MOS.

C-15. On the spot RVT training is not generally sufficient for maneuver units. Units need to request and train with RVTs during field training exercises and regularly scheduled UA flight operations.

C-16. The UAS is a valuable battlefield asset. Like any other system, it will not function effectively without skilled operators, maintainers, and supervisors. Therefore, institutional and unit sustainment training is required for all UAS personnel.

INSTITUTIONAL TRAINING

C-17. A Soldier, completing basic training or reclassification, arrives at the United States Army Intelligence Center and Fort Huachuca for advanced individual training (AIT). UAS operators (MOS 15W) and maintenance training (MOS 33W and 52D) is a further subdivision of training. MOSs 33W and 52D Soldiers receive additional UAS training and an ASI of U2 for the RQ-7 Shadow and U3 for the RQ-5/MQ-5 Hunter. Soldiers attending the maintenance portion of UAS training have completed the core MOS 52D AIT at Aberdeen Proving Grounds, Maryland, or the core MOS 33W AIT at Fort Huachuca, Arizona. Students completing AIT participate in collective training and an end-of-course field training exercise.

C-18. Institutional training teaches the following MOS 15W tasks at skill level 10:

- L/R operations.
- UA operations.
- Payload operations.
- Operator level maintenance.
- System safety and safety mishap hazard reporting procedures.
- MPO tasks include—
 - Search techniques.
 - Target recognition.
 - Indirect fire adjustment.
 - Order of battle (OB).
 - C2.
 - Request, tasking, and reporting procedures.

C-19. EP (Hunter only) is a skill level 20 and requires additional training.

C-20. MOS 15W Basic Noncommissioned Officers Course teaches subjects for key positions of MC, flight line chief, and data exploitation operator.

C-21. MOS 33W and MOS 52D Soldiers receive UAS system electronic warfare/intercept (EW/I) training along with leader and supervisor courses as needed.

C-22. Use of Army common training is for security tasks, communication tasks, and map reading. Institutional training devices include—

- Ground station simulator.
- UA mock-up.
- Mission payload mock-up.
- Radio controlled model airplanes (Hunter EP training only).
- UA scale model (Hunter EP training only).
- Maintenance simulator.

UNIT SUSTAINMENT TRAINING

C-23. The unit commander conducts sustainment training to ensure operator proficiency. New equipment training or other mobile training teams provides doctrine and TTP at major command locations during the fielding of systems. The commander then maintains proficiency using FMs, training exercises, and drills containing the doctrine and TTP. Examples of unit sustainment training include—

- Crew chief qualification.
- Additional payload training.

- Data exploiter (DE) training.
- MC training.

SECTION II—NATIONAL AIRSPACE SYSTEM

FEDERAL AVIATION ADMINISTRATION

C-24. AR 95-2 prescribes Army airspace management in the National Airspace System (NAS). Rigid control of UAS operations occurs to avoid hazards to other air traffic. The following restrictions apply to UAS operations:

- Conduct flights within restricted airspace approved for UAS operations.
- Conduct flights within Class A airspace provided such flights have been properly coordinated with the Federal Aviation Administration (FAA).
- Conduct flights within warning areas provided such flights have been properly coordinated with the Department of the Navy and the FAA.
- Outside of the above areas (with the exception of UAS classified as model aircraft), the UA must be accompanied by a chase plane with direct communications to the UAS controlling facility. The chase plane operator's responsibility is to relay potential conflicts to the UAS controlling facility and provide changes of heading and altitude to resolve any traffic conflicts. If units have an alternate means of observing UA flight and communications with the UAS controlling facility that provide a level of safety equal to that provided by the chase plane, approval is at the discretion of the concerned FAA region. VOs conduct operations in visual flight rules conditions. Examples include visual observation from one or more ground sites and positive primary radar observation.

SPECIAL USE AIRSPACE ACQUISITION

C-25. Installation commanders, responsible for activities within the NAS, will comply with AR 95-2 by designating an installation air traffic and airspace (AT&A) officer to represent the commander on matters pertaining to the NAS. The regulation defines policy, assigns responsibility, and specifies the actions required for special use airspace acquisition (including a suggested format). The regulation also establishes the requirement for an annual review concerning the adequacy of special-use airspace.

C-26. UAS commanders are responsible for acquiring special-use airspace adequate to conduct unit training. If no restricted area exists where the UAS operation is planned, a proposal to establish a restricted area must be developed, coordinated, and submitted through the AT&A officer to the FAA for review and implementation action. After receipt of the proposal, the FAA has a minimum time of 6 months to establish a restricted area. If existing restricted areas are available but not designated for UAS operations, the AT&A officer has the responsibility to initiate a change.

C-27. Airspace requests should include L/R locations, minimum and maximum altitudes, area to be used, and any special requirements. Personnel can submit requests to operate UAS outside of restricted airspace to the assistant chief of staff-operations and plans (G3) and S3 Air no later than 14 days before the proposed training mission. Requests include but are not limited to the—

- Date of mission.
- Scheduled time the UA is to depart and re-enter restricted airspace.
- Proposed flight path and altitudes.

- Emergency landing site.
- Chase plane requirements.

C-28. The G3 and S3 Air coordinate with the local AT&A officer or area FAA ATC center, as appropriate, for restricted airspace operations and for operations outside restricted airspace. Stereo flight plans (plans for which all parameters are established and remain the same) may be put on file with the G3 Air to reduce filing time requirements. Filing stereo flight plan information is found in FAA 7110.10R, Flight Services publication online.

This page intentionally left blank.

Appendix D

Army Unmanned Aircraft System Contributions to Joint Operations

This appendix outlines procedures for obtaining Army UAS support in conducting joint operations. Army UAS can make significant contributions to the warfighting capability of operational and tactical forces. The commander must integrate and synchronize all assigned and available Army UAS and command, control, communications, computers, and intelligence (C4I) systems with the mission cycle, including launch platforms and weapons. This includes the capability to fuse and correlate both the operations and output of the UAS and C4I using sensors; information processing; C2; and communications capabilities, systems, and functions for a more consistent and clearer picture of the battlespace. Army UAS can support each element of air, land, sea, and special operations teams to facilitate the application of overwhelming force. The UAS challenge is providing the commander timely, objective, responsive, complete, accurate, and relevant information.

D-1. The current Army UAS supporting joint operations are I-Gnat, Hunter, and Shadow. Raven UAS has limitations in range (15 kilometers) and endurance (maximum of 90 minutes) preventing the system from fully participating in joint operations. This does not discount, however, the availability and use of information derived from previous Raven missions. Consequently, for the purposes of this appendix, all references to participating Army UAS pertain to I-Gnat, Hunter, and Shadow.

COLLECTION MANAGEMENT

D-2. Army UAS are key resources supporting the full range of operational and tactical ISR requirements. Therefore, planning for the employment of Army UAS capabilities to meet force-wide ISR requirements is best when accomplished as an integral part of the joint force collection management process. Incorporation of all UAS deliberate (preplanned) missions, even those tasked by service or functional components, will be into the ATO process.

RECONNAISSANCE, SURVEILLANCE, AND TARGET ACQUISITION

D-3. Army UAS perform RSTA missions for joint operations, providing information on enemy forces and installations. RSTA operations may require both continuous surveillance and reconnaissance to provide timely indications and warning of an imminent or impending threat attack. UAS conducting RSTA missions provide commanders with current data on enemy terrain, organization, infrastructure, and forces necessary for planning theater campaigns and major operations, including contingencies. UAS also provide for adaptive, real-time planning for current operations, including monitoring enemy centers of gravity, conventional attack capabilities, enemy offensive and defensive positions, deception postures, and BDA.

COMMUNICATIONS INTEGRATION AND INTEROPERABILITY

D-4. The UAS GCS processes and prepares imagery information from RSTA missions. Army UAS do not have the organic capability to transmit imagery from the GCS. Electronic mail can have single video

frames attached and transmitted via the secret internet protocol router network (SIPRNET), thereby providing imagery information to the supported command by tactical communications. Those UAS units have the capability to furnish videotapes of missions to service intelligence agencies for analysis. Personnel disseminate information in digital message format and freeze frame imagery (national imagery transmission format) to the theater intelligence system via—

- Army ABCS.
- USAF Theater Battle Management Core System (TBMCS).
- USN Global Command and Control System – Maritime.
- USMC tactical combat operation system.

D-5. Users with the appropriate Army UAS RVT can receive real-time imagery from the UA. For example, to receive Shadow imagery the user must possess a Shadow RVT; any other Army UAS RVT would not be compatible. Each Army UAS transmits in the omni-directional mode and the user must be within 40 kilometers for Hunter and 50 kilometers for Shadow. Currently I-Gnat does not possess a RVT. Users pass combat information directly to the service FECs through service tactical communications for immediate TA and targeting.

D-6. Secure communications systems are used exclusively, including secure SINCGARS, DSN (using the STU-III phone), and MSE and SIPRNET. Although voice communications systems are handy for quick coordination, SIPRNET has proven to be the system of choice for passing mission requests, targets, and mission summaries.

REQUEST AND TASKING PROCEDURES

D-7. The Army BCD receives all requests for Army UAS mission support. UAS requests, tasking, and reporting procedures vary (depending on the type of system, echelon of deployment, command relations, and support relations); therefore, standard tasking and reporting procedures were developed. Whenever possible, the appropriate echelon collection manager should receive a mission request at least 24 hours before the mission or in-flight modification to an ongoing mission. This requires timely, detailed coordination between the asset manager and A2C2 cell to ensure successful mission execution. Not intended to cover all the possibilities, the following paragraphs provide guiding principles.

D-8. To enhance communications, the selected Army UAS provides two liaison personnel to the JAOC/BCD, allowing the liaison personnel to operate 24 hours a day. The UAS liaison personnel represent the UAS commander at the JAOC/BCD, advise the JAOC/BCD personnel on UAS TTP, and coordinate UAS flights. The selected Army UAS unit operations personnel should periodically contact its liaison team at the JAOC/BCD to verify specifics in airspace measures.

D-9. Forward requests for support to the Army BCD who prioritizes requirements, selects the UAS unit, and coordinates the airspace through the A2C2 element.

- For hasty (immediate) missions or in-flight diversions, the Army BCD transmits tasking directly to the GCS/MPS and provides an information copy to the parent unit TOC.
- For deliberate (preplanned) UAS missions, the BCD forwards tasking through the chain of command to the parent unit TOC, and then to the UAS unit and GCS/MPS for execution.

REPORTING

D-10. After collecting the target, data recovery and dissemination flows from the GCS or directly from the UA to a RVT. Units conduct normal reporting through voice or data messages detailing observed activity. The GCS produces the reports and sends them to the ASAS or other consumers. For example, finding a high-value or time-sensitive target generates a voice report to the UAS LNO (an experienced individual from a UAS unit) in the JAOC/BCD. This allows the JFACC (or unit assigned tasking authority) immediate access to retask the platform in NRT. Transmission of the video may be in real time via Trojan

Spirit to a GBS injection site. Exploited images are disseminated via the supported theater's intelligence dissemination architecture. Personnel send targeting, fire adjustment, and target damage assessment messages to the AFATDS. Hard copy photos or recorded video may also be used as well as remote television monitors from the GCS to the supported TOC/facility. Tasking and reporting flow is depicted in figure D-1.

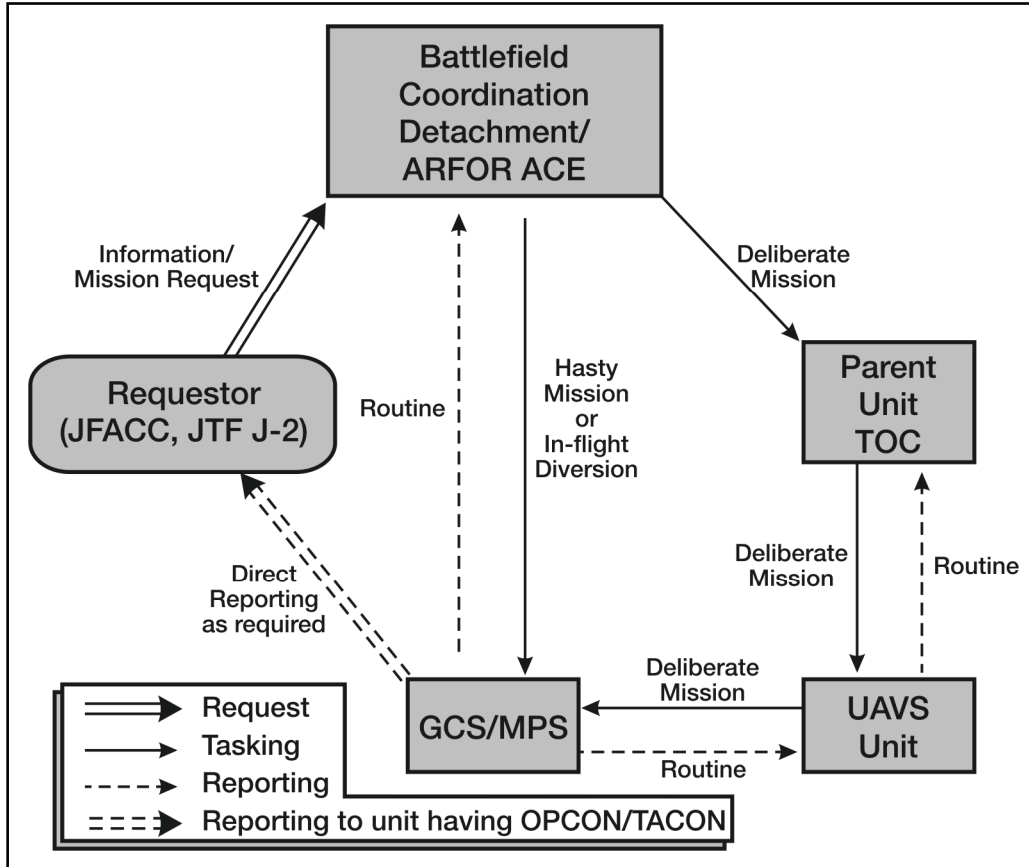

Figure D-1. Tasking and reporting

This page intentionally left blank.

Appendix E

Recovery of Unmanned Aircraft

This appendix outlines recovery and safety considerations for downed Army UAS. Safety is of foremost consideration for all participating recovery personnel as most UA have one or more items classified as hazardous materials (for instance, AVGAS, MOGAS, batteries, parts of the sensor payload, and others). Commanders should manage the creation, documentation, and regular training of a comprehensive plan to ensure UA recovery is completed in a safe and timely manner.

SECTION I—HUNTER AND SHADOW

RECOVERY RESPONSE PLAN

- E-1. The recovery response plan outlines the specific duties and responsibilities applicable to the personnel required to perform an accident investigation in the event of a catastrophic failure. Notification includes all initial requirements. A running log of all actions encompasses agencies notified, person's names, and times of contact.
- E-2. If the UA is over a hostile environment, the recovery parachute will not deploy. The VO makes every effort not to crash the UA near civilians.
- E-3. If the UA is over an isolated area, the MC makes the decision to deploy the recovery parachute.
- Deploy the recovery parachute if the UA is within 10 minutes ground vehicle driving distance.
 - Deploy the recovery parachute during all flights in a training environment.

ACCIDENT REPORTING

- E-4. In the event of a downed UA, the MC ensures notification of ATC and the ALO via frequency modulation, VHF, UHF, digital narrowband voice terminal or MIRC to confirm last known location of the UA via mode 3 A/C IFF.
- E-5. The MC informs the C2 cell of location, time, and possible cause of the downed UA.
- E-6. The C2 cell opens a running log (DA Form 1594, Daily Staff Journal or Duty Officer's Log) of all actions taken, agencies notified, and names with times of contact.
- E-7. The C2 cell notifies the brigade S3/division G3 (based on level of support) relaying necessary information and current SITREP. The brigade S3 section determines availability of the nearest maneuver unit to move in and secure the UA crash site.

RECOVERY AND INVESTIGATION

- E-8. Because of the small amount of fuel on board, the likelihood of significant damage to the environment or surrounding structures is small. The UA is manufactured from carbon fiber, and burning

produces hazardous fumes. Respirators must be used within 300 feet of a burning UA. The normal procedure is to let the aircraft burn when not endangering life or property. If the UA experiences an in-flight emergency warning or severe weather, the VO contacts ATC and request Emergency Return to Base for landing.

Vicinity United States Troops

E-9. It is the responsibility of the MC to evaluate the situation quickly and activate the preaccident plan when warranted. If the UA crashes within a secure area, the brigade S3/G3 will deploy a four-person downed UA recovery crew with any additional security team (based on situation) to investigate/recover the wreckage and secure the IFF transponder. The downed UA recovery crew utilizes the investigation kit and completes the required forms. If applicable, the brigade TOC is notified immediately and an initial serious incident report is filed within 4 hours. Upon completion of the investigation and photos (time permitting), the UA is loaded into the HMMWV with maximum effort on preserving any of the wreckage possible for further analysis.

Isolated Areas

E-10. After reviewing the situation surrounding the downed UA, the battalion commander determines the requirement to recover the UA. It is the responsibility of supervisory personnel to evaluate the situation and activate the preaccident plan when warranted. If the UA crashes in an isolated area, the brigade S3/division G3 will notify the aviation brigade S3 operations section and request support for observation/movement of downed UA recovery crew to crash site. The brigade S3/division G3 informs the aviation brigade S3 if additional assistance is required to locate and secure the UA. A 4-person downed UA recovery crew with an additional security team (based on situation) flies out to investigate, recover the wreckage, and secures the IFF transponder. Upon completion of investigation and photos (time permitting), the UA is loaded onto the aircraft with maximum effort on preserving wreckage for possible further analysis.

EMERGENCY RECOVERY TEAM CHECKLIST

E-11. The following is an example of a Shadow emergency recovery team checklist (table E-1).

Table E-1. Example of a Hunter/Shadow emergency recovery team checklist

<i>Hunter / Shadow Emergency Recovery Team Checklist</i>	
	Secure downed UA kit, recovery vehicle with trailer, and map with downed UA plotted.
	Assemble recovery team and, if possible, a combat lifesaver.
	Confirm downed UA grid location with MC and establish route to site.
	Perform communications checks prior to departure to site.
	Perform communications checks with aviation assets as required.
	Insure team members are personally equipped for mission.
	Link up with additional security team.
	Thoroughly brief team members on actions to take.
	Upon arrival at site extinguish/contain fires when appropriate (Do not attempt to extinguish UA if burning, stand 300 ft upwind).
	Secure/contain hazardous materials as required.

Table E-1. Example of a Hunter/Shadow emergency recovery team checklist

<i>Hunter / Shadow Emergency Recovery Team Checklist</i>	
	Provide medical assistance as appropriate.
	Secure the site, report property damage, and make every effort to preserve wreckage without destroying the evidence.
	After a thorough investigation is complete and photos are taken (time permitting), secure the UA in the HMMWV trailer attempting to preserve as much of the wreckage as possible.

RESPONSIBILITIES**Platoon Leader/Warrant Officer**

E-12. Platoon leaders and warrant officers ensure personnel execute the plan by producing exact guidance, appropriate checklists, and POCs. They ensure the preaccident plan is distributed to all major areas (maintenance, operations, and others). They execute notification and complete DA Form 1594. In the event of a downed UA, the platoon leader or warrant officer proceeds to the operational site to oversee rescue/recovery efforts.

Mission Commander

E-13. The MC contacts ATC to confirm location of downed UA with last known location of mode 3 A/C IFF. He then plots the crash on the crash grid map, monitors radio transmissions regarding the downed UA, and briefs/updates the platoon leader/warrant officer on the current situation.

Maintenance (33W & 52D)

E-14. Maintainers not involved with the flight or maintenance of the downed UA are selected. They collect fuel and oil samples for evaluation (QA), provide recovery equipment as required, and assist in investigation as required. Maintainers also secure all related items, including samples in a locked box with an updated checklist. If an investigation takes place, personnel vacate the GCS shelter and secure the door.

SUPPLY

E-15. Supply personnel inventory and maintain the downed UA kit. They issue necessary Class I supply items for response and recovery team and obtain items as necessary when this plan is activated.

E-16. All personnel with an assigned position on the downed UA recovery crew will be familiar with their assigned responsibilities and thoroughly knowledgeable with the investigation.

Downed Unmanned Aircraft Kit List

E-17. Personnel will secure downed UA kit items. The downed UA kit includes, but is not limited to, the following items (table E-2):

Table E-2. Example of a Hunter/Shadow downed UA kit checklist

	<i>Items</i>	<i>Quantity</i>
	Cell phone or two-way radio to base	1 each
	Digital or standard camera	1 each
	Standard camera film & batteries	*
	Lap top computer for compiling data	1 each
	Tape recorder (small)	1 each
	Blank tapes	3 or 4 each
	Tape recorder batteries	*
	GPS to plot wreckage, obtain headings, and spot elevation	1 each
	Map - 1:50,000 (good), 1:25,000 (preferred)	*
	Magnifying glass	*
	Magnetic compass	*
	Tape measure: 50 ft or 100 ft (preferred)	*
	Ruler (12 inches or 18 inches)	*
	First-aid kit with tweezers	*
	Latex/vinyl gloves	3-4 dozen
	Leather gloves	4 pairs
	Dust masks	2-3 dozen
	Goggles or safety glasses	4 sets
	Boundary tape to mark site perimeter 500'	*
	Concertina wire	*
	Graph paper on clipboard	*
	Pens/pencils, indelible markers, chalk, and one can of spray paint.	*
	Pocket-size notebooks	4 each
	Calculator	2 each
	Baggies (gallon size)	4 dozen
	Pre-labeled Army oil analysis program (AOAP) bottles	1 each-fuel & oil
	Paper towels or equivalent	*
	Spill kit	*
	Tool kit	*
	Flashlight	2 each
	Flashlight batteries	*
	DA Form 2823 Sworn Statement	*
	DA Form 7305-R Telephonic Notification of Aviation Accident/Incident	*

Table E-2. Example of a Hunter/Shadow downed UA kit checklist

	<i>Items</i>	<i>Quantity</i>
	DA Form 7306-R Telephonic Notification of Ground Accident	*
	Biohazard bags	*
	HMMWV with trailer to transport supplies and collect wreckage	*
	Aircraft when aviation support is available	*
*Quantity at unit discretion		

Spill Kit

E-18. Personnel will secure spill kit items. See table E-3.

Table E-3. Example of a Hunter/Shadow spill kit checklist

	<i>Items</i>	<i>Quantity</i>
	Absorbent pads	2 boxes
	Short handle shovels	2 each
	Pick axe	1 each
	Sledge hammer	1 each
	Wood stakes	25 each
	Large garbage bags w/ties	100 each
	Sand bags	25 each
	55 gal removable top drum	1 each
	Lights (portable)	1 set
	Gloves (chemical)	10 sets
	Safety masks (dust)	10 each
	Sheet, plastic	1 roll
	Yellow "off limits" tape	1 box
	Dry sweep	1 50-lb bag
	Goggles	3 pair

UAS RECOVERY MARKINGS

E-19. A technique used to aid in recovery of an UA is to mark the UA with instructions for return to United States Army military personnel and (or) a promise of a reward in the language of the region. Figure E-1 is an example of a sticker created with the help of an Iraqi linguist (Arabic language). This sticker is placed on each Raven UA.



Figure E-1. UA recovery markings

E-20. A separate sheet of paper was also placed on the Raven units along with the stickers. On it the name of each FOB was written in English with the corresponding Arabic spelling to the right. The FOB name is placed in the blank underlined area found on the sticker.

SECTION II—RQ-11 RAVEN RECOVERY

E-21. The Raven UA design includes an autoland feature which is initiated between 50 and 100 feet AGL and causes the UA to descend in a deep stall. The UA design is such that a hard impact with the ground will allow UA components to separate. This is normal and helps dissipate the impact of landing and protect the UA. A landing pad on the bottom of the fuselage also provides impact protection. The durable nature and design features of the UA mean the UA is salvageable after an accident involving an uncommanded landing. There is a greater chance of UA damage at altitudes higher than 100 feet.

DOWNED UNMANNED AIRCRAFT RECOVERY

E-22. If an UA lands outside of visual range—

- Go to BLACK SCREEN and record all necessary flight data. Initiate the BLACK SCREEN by simultaneously pressing ENTER and PAGE to disable/enable the video signal to the applicable controller. This allows the operator to view text overlay when static is excessive.
- Assemble recovery equipment and refer to TTP manual.
- Plan the recovery mission.
- Attempt to locate UA using last known location

E-23. If UA is not located—

- Check for signal from UA using RVT.
- Conduct search using last known location and heading.

E-24. Recovery and inspection include—

- Retrieve the fuselage first, keeping the body away from the propeller area.
- Disconnect the battery from the aircraft.

- Gather the remainder of the aircraft components.
- Inspect all components for damage. Generally, minor dents or cracks do not require immediate maintenance before launching again. However, be wary of flying an aircraft with damage to the leading edge of the center wing and wingtips, horizontal stabilizer, or vertical stabilizer, as these control flight. Detailed inspection procedures appear in the following paragraphs.

E-25. Suggested items to include in a Raven downed UA recovery kit (table E-4).

Table E-4. Example of a Raven downed UA recovery kit checklist

	<i>Items</i>	<i>Quantity</i>
	Rope	*
	Saw	*
	Tree spikes and climbing harness (for tree climbing).	*
	Folding ladder	*
	Extension pole/hook	*
	Net or poncho liner to catch/prevent further damage to UA falling from tree	*
	Trading material (food, candy, money, or other items can be used to barter with civilians for return of lost UA).	*
	Gloves	*
	Goggles	*
	Night vision devices	*
	RVT (utilize RVT to acquire signal from downed UA).	*
*Quantity at unit discretion		

INSPECTION

E-26. There are three main ways to identify problems with the aircraft:

- Conduct a visual inspection.
- Observe incorrect response to correct input.
- Swap working parts from another working aircraft to identify the damaged part.

E-27. Personnel must frequently inspect the aircraft for damage and repair any discrepancies found at the appropriate level.

NOSE

E-28. When inspecting the nose, check—

- For dents and cracks in the skin.
- Camera lenses (clean them with the lens brush and (or) glass cloth).
- Nose/fuselage connectors for cracks and a secure connection.
- Electrical contacts (need to be free of grit or dust).

CENTER WING AND WINGTIPS

E-29. When inspecting the center wing and wingtips, check —

- For dents and cracks in the skin.
- For buckling in the wing spar caps (reinforcing structure in the wing that appears as a gray shadow along the length of the center wing and wingtips). Damage to the wing spar caps prevents the aircraft from flying and necessitates a depot level repair.
- Wing-pins (that hold the wingtip to the center wing) for damage.
- The o-rings on the wing-pin for damage (these hold the wingtip securely to the center wing).
- The wing snap screws on the center wing.
- That the leading edge of the wing has maintained its shape.

FUSELAGE

E-30. When inspecting the fuselage, check —

- For dents and cracks in the skin.
- Wing snap screws.
- Electrical contacts (need to be free of grit or dust).
- Antenna is intact.
- Landing pad is secure and not damaged.

PROPELLER

E-31. When inspecting the propeller, check —

- Propeller for cracks and nicks.
- Propeller is secure.

TAILBOOM

E-32. When inspecting the tailboom, check —

- For dents and cracks in the skin.
- Tailboom is fasten securely to the fuselage.
- Electrical contacts are free of grit or dust.
- Stabilizer horn pivot housing is firmly seated in the end of the tailboom.
- Centering of the stabilizer pivot pin in the housing.

HORIZONTAL STABILIZER

E-33. When inspecting the horizontal stabilizer, check —

- For dents and cracks in the skin.
- Stabilizer clip for damage.

E-34. The final check should be for general alignment. Looking down the nose of the aircraft, all the components should be straight and aligned without any skewing.

Glossary

SECTION I – ACRONYMS AND ABBREVIATIONS

1SG	first sergeant
A2C2	Army airspace command and control
A2C2S	Army airborne command and control system
AA	assembly area
AADC	area air defense commander
AAR	after-action review
ABCS	Army Battle Command System
ACA	airspace control authority
ACM	airspace control measure
ACO	airspace control order
ACP	airspace control point
AD	air defense
ADA	air defense artillery
ADAM	air defense airspace management
AF	Air Force
AFATDS	Advanced Field Artillery Tactical Data System
AGL	above ground level
AGM	air-launched guided missile
AH	attack helicopter
AIRSUPREQ	air support request
AIT	advanced individual training
ALO	air liaison officer
ALOC	administrative and logistics operations center
AMC	air mission commander
AO	area of operations
AOR	area of responsibility
AR	Army regulation
ARFOR	Army forces
ARTEP	Army training and evaluation program
ASAS	All-Source Analysis System
ASI	additional skill identifier
AT&A	air traffic and airspace
ATC	air traffic control
ATM	aircrew training manual
ATO	air tasking order
ATP	aircrew training program

UA	unmanned aircraft
AVGAS	aviation gasoline
AVT	air vehicle transport
AWACS	Airborne Warning and Control System
BAE	brigade aviation element
BAO	brigade aviation officer
BCD	battlefield coordination attachment
BCT	brigade combat team
BDA	battle damage assessment
BDZ	base defense zone
BFSB	battlefield surveillance brigade
BFT	blue force tracking
BIT	built-in test
BP	battle position
C2	command and control
C3	command, control, and communications
C4I	command, control, communications, computers, and intelligence
CALL	Center for Army Lessons Learned
CAS	close air support
CATS	combined arms training strategies
CBRN	chemical, biological, radiological, and nuclear
CCA	close combat attack
CCIR	commander's critical information requirements
CGRS	Common Geographic Reference System
CGS	common ground station
CIC	command information center
CLS	contractor logistic support
COA	course of action
COMSEC	communications security
COP	common operational picture
CP	command post
C-RAM	counter-rocket, artillery, and mortar
CRP	communications relay package
DA	Department of the Army
DA Pam	Department of the Army pamphlet
DART	downed aircraft recovery team
DCPA	digital central processing assembly
DE	data exploiter
DES	Directorate of Evaluation and Standardization
DOD	Department of Defense
DP	decision point

DS	direct support
DSN	Defense Switch Network
DTG	date-time-group
DZ	drop zone
ECOORD	effects coordinator
ECW	extended center wing
EO	electro-optical
EP	external pilot
EW	electronic warfare
EW/I	electronic warfare/intercept
FA	field artillery
FAA	Federal Aviation Administration
FARP	forward arming and refueling point
FBCB2	Force XXI battle command brigade and below
FEC	fires and effects cell
FF	future force
FLIR	forward looking infrared
FLOT	forward line of own troops
FM	field manual
FO	forward observer
FOB	forward operating base
FOV	field of view
FRA	forward repair activity
FRAGO	fragmentary order
FS	fire support
FSB	forward support battalion
FSCL	fire support coordination line
FSCM	fire support coordinating measure
FSE	fire support element
FSO	fire support officer
FY	fiscal year
G2	Assistant Chief of Staff-Personnel
G3	Assistant Chief of Staff-Operations and Plans
GBS	Global Broadcast System
GCS	ground control station
GCU	ground control unit
GDT	ground data terminal
GMTI	ground moving target indicator
GPS	global positioning system
GS	general support
GSE	ground support equipment

GSR	ground surveillance radar
HF	high frequency
HMMWV	high mobility multipurpose wheeled vehicle
HPT	high payoff target
HVT	high value target
IDS	Integrated Deepwater System
IED	improvised explosive device
IFF	identification friend and foe
IFRF	individual flight records folder
INS	inertial navigation system
IP	instructor pilot
IPB	intelligence preparation of the battlefield
IR	infrared
ISR	intelligence, surveillance, and reconnaissance
J2	intelligence directorate of a joint staff; intelligence staff section
J3	operations directorate of a joint staff; operations staff section
JAAT	Joint air attack team
JAC	Joint Analysis Center
JAOC	Joint Air Operations Center
JBS	Joint Broadcast System
JDISS	Joint Deployable Intelligence Support System
JFACC	Joint force air component commander
JFC	Joint force commander
JIC	joint intelligence center
JIM	joint, interagency, and multinational
JP	joint publication
J-SEAD	joint suppression of enemy air defense
JSTARS	Joint Surveillance Target Attack Radar System
JTAC	joint terminal attack controller
JTF	joint task force
JTRS	joint tactical radio system
L/R	launch and recovery
LAN	local area network
lb	pound
LC	line of contact
LD	line of departure
LDRF	laser designator and rangefinder
Li-Ion	lithium-ion
LNO	liaison officer
LOC	line of communications
LOL	loss of link

LOS	line of sight
LRE	launch and recovery element
LRF/D	laser range finder/designator
LRS	launch and recovery station
LRU	line replaceable unit
LZ	landing zone
MC	mission commander
MCE	mission control element
MDA	maritime domain awareness
METL	mission essential task list
METT-TC	mission, enemy, terrain and weather, troops and support available, time available, and civil considerations
MFOV	medium field of view
MI	military intelligence
MIRC	multi-use internet relay chat
mm	millimeter
MMF	mobile maintenance facility
MMIST	Mist Mobility Integrated Systems Technology
MOGAS	motor gasoline
MOS	military occupational specialty
MOSP	multit-mission optronic stabilized payload
MPCS	mission planning and control site
mph	mile per hour
MPO	mission payload operator
MPS	mission planning station
MSB	mission support briefing
MSE	mobile subscriber equipment
MSL	mean sea level
MSR	main supply route
MTI	moving target indicator
MTOE	modified table of organization and equipment
MTP	mission training plan
MTS	multi-spectral targeting system
MUM	manned, unmanned
NAI	named area of interest
NAS	National Airspace System
NCO	noncommissioned officer
NCOIC	noncommissioned officer in charge
NFOV	narrow field of view
NLOS	non-line of sight
nm	nautical mile

NOTAM	notice to airmen
NRT	near real time
O&I	operations and intelligence
OB	order of battle
OEF	Operation Enduring Freedom
OFED	operational fires and effects directorate
OH	observation helicopter
OIC	officer in charge
OIF	Operation Iraqi Freedom
ONR	Office of Naval Research
OP	observation post
OPFOR	opposing forces
OPORD	operation order
OPSEC	operations security
PCI	precombat inspections
PFPS	portable flight planning system
PGCS	portable ground control station
PID	positive identification
PIR	priority intelligence requirements
PM	program manager
POC	point of contact
POI	point of interest
POL	petroleum, oils, and lubricants
POP	Plug-in optronic payload
PP	passage point
PPSL	Predator primary satellite link
PR	personnel recovery
PSG	platoon sergeant
PZ	pickup zone
QA	quality assurance
QRF	quick reaction force
R&S	reconnaissance and surveillance
RAV	risk assessment value
RETRANS	retransmission
ROA	restricted operations area
ROE	Rules of engagement
ROVER	remote operations video enhanced receiver
ROZ	restricted operations zone
RP	release point
RSTA	reconnaissance, surveillance, and target acquisition
RTO	radio telephone operator

RVT	remote video terminal
RWS	remote workstation
S2	intelligence staff officer
S3	operations staff officer
S4	logistics staff officer
SA	situational awareness
SAAFR	standard-use Army aircraft flight route
SAM	surface-to-air missile
SAR	synthetic aperture radar
SATCOM	satellite communications
SBCT	Stryker brigade combat team
SEAD	suppression of enemy air defense
SHORAD	short-range air defense
shp	shaft horsepower
SID	secondary imagery dissemination
SIGINT	signal intelligence
SINGARS	single channel ground airborne radio system
SIPR	secret internet protocol router
SIPRNET	secret internet protocol router network
SITREP	situation report
SO	safety officer
SOP	standing operating procedure
SP	standardization pilot
SPINS	special instructions
ST	special text
STP	soldier training publication
STU	secure telephone unit
SU	situational understanding
SUAS	small unmanned aerial vehicle
TA	target acquisition
TAC	terminal attack controller
TACON	tactical control
TAGS	Theater Air-Ground System
TAI	targeted area of interest
TAIS	tactical airspace integration system
TALS	tactical automated landing system
TBMCS	theater battle management core system
TC	training circular
TCDL	tactical common data link
TF	Task force
TLP	troop leading procedures

TOC	tactical operations center
TOT	Time on target
TS	Trojan Spirit
TTP	tactics, techniques, and procedures
TUAV	tactical unmanned aerial vehicle
UA	unmanned aircraft
UAS	Unmanned Aircraft System
UET	Unmanned Aircraft System exploitation team
UH	utility helicopter
UHF	ultra high frequency
USAAWC	United States Army Aviation Warfighting Center
USACRC	United States Army Combat Readiness Center
USAF	U.S. Air Force
USMC	United States Marine Corp
USN	United States Navy
USSOCOM	United States Special Operations Command
UT	unit trainer
VCR	video cassette recorder
VHF	very high frequency
VO	vehicle operator
WARNO	warning order
WebACMR	web page for airspace control means requests and tracking
WX	weather

References

The bibliography lists field manuals by new number followed by old number. These publications are sources for additional information on the topics in this Field Manual. Most joint publications can be found at <http://www.dtic.mil/doctrine/index.html>.

Most Army doctrinal publications are available online at <https://akocomm.us.army.mil/usapa/doctrine/index.html>.

Aviation Liaison Officer (LNO) Handbook, United States Army Aviation Warfighting Center. July 2001.

Allied Administrative Publication-4 (AAP-4). *NATO Standardization Agreements and Allied Publications*. 1 February 2003.

AR 95-1. *Flight Regulations*. 3 February 2006.

AR 95-2. *Air Traffic Control, Airspace, Airfields, Flight Activities and Navigational Aids*. 10 August 1990.

AR 95-20. *Contractor's Flight and Ground Operations*. 13 November 2002.

AR 95-23. *Unmanned Aerial Vehicle Flight Regulations*. 14 May 2004.

AR 200-1. *Environmental Protection and Enhancement*. 21 February 1997.

AR 200-2. *Environmental Effects of Army Actions*. 23 December 1988.

AR 385-10. *The Army Safety Program*. 29 February 2000.

AR 385-40. *Accident Reporting and Records*. 1 November 1994.

AR 385-95. *Army Aviation Accident Prevention*. 10 December 1999.

AR 700-138. *Army Logistics Readiness and Sustainability*. 26 February 2004.

AR 710-1. *Centralized Inventory Management of the Army Supply System*. 6 September 2005.

AR 710-2. *Supply Policy Below the National Level*. 8 July 2005.

AR 710-3. *Asset and Transaction Reporting System*. 31 March 1998.

AR 750-1. *Army Materiel Maintenance Policy*. 23 January 2006.

ARTEP 34-117-30-MTP. *Mission Training Plan for the Surveillance Troop of the Stryker Brigade Combat Team*. 28 June 2005.

ARTEP 34-387-10-DRILL. *Crew Drills for the Shadow 200 Tactical Unmanned Vehicle (TUAV)*. 20 November 2005.

ARTEP 34-387-30-MTP. *Mission Training Plan for the Direct Support Military Intelligence Company (Digitized)*. 30 September 2004.

ARTEP 34-414-10-DRILL. *Crew Drills for the Hunter Tactical Unmanned Aerial Vehicle (TUAV)*. 21 February 2006.

ARTEP 34-414-30-MTP. *Mission Training Plan for the Aerial Reconnaissance Company (Aerial Exploitation) (Corps)*. 2 December 2002.

References

- DA Form 1594. *Daily Staff Journal or Duty Officer's Log*.
- DA Form 2028. *Recommended Changes to Publications and Blank Forms*.
- DA Form 2823. *Sworn Statement*.
- DA Form 4507-R. *Crew Member Grade Slip*.
- DA Form 5484-R. *Mission Schedule/Brief*.
- DA Form 7120-R. *Commander's Task List*.
- DA Form 7122-R. *Crew Member Training Record*.
- DA Form 7305-R. *Telephonic Notification of Aviation Accident/Incident*.
- DA Form 7306-R. *Worksheet for Telephonic Notification of Ground Accident*.
- DA Pam 25-30. *Consolidated Index of Army Publications and Blank Forms*.
- DA Pam 385-40. *Army Accident Investigation and Reporting*. 1 November 1994.
- DA Pam 710-2-1. *Using Unit Supply System (Manual Procedures)*. 31 Dec 1997.
- DA Pam 710-2-2. *Supply Support Activity Supply System: Manual Procedures*. 30 September 1998.
- DD Form 175-1. *Flight Weather Briefing*.
- DD Form 1972. *Joint Tactical Air Strike Request*.
- DD Form 1975. *Joint Tactical Air Reconnaissance/Surveillance Request*.
- FAA Order 7110.10R, *Flight Services*.
- FM 1 (FM 100-1). *The Army*. 14 June 2001.
- FM 1-02 (FM 101-5-1). *Operational Terms and Graphics*. 21 September 2004.
- FM 1-120. *Army Air Traffic Services Contingency and Combat Zone Operations* (will be revised as FM 3-04.120). 22 May 1995.
- FM 2-0 (FM 34-1). *Intelligence and Electronic Warfare Operations*. 17 May 2004.
- FM 3-0 (FM 100-5). *Operations*. 14 June 2001.
- FM 3-04.111. *Aviation Brigades*. (Pending final draft date).
- FM 1-113. *Assault Helicopter Battalions*.
- FM 3-04.300 (FM 1-300). *Flight Operations Procedures*. 26 April 2004.
- FM 3-04.500 (FM 1-500). *Army Aviation Maintenance*. 26 September 2000.
- FM 3-04.564 (FM 1-564). *Shipboard Operations*. (Pending final draft date).
- FM 3-05.30. *Psychological Operations*. 15 April 2005.
- FM 3-05.60 (FM 1-108). *Army Special Operations Forces Aviation Operations*. 16 October 2000.
- FM 3-07 (FM 100-23). *Stability Operations and Support Operations*. 20 February 2003.
- FM 3-3. *Chemical and Biological Contamination Avoidance* (will be revised as FM 3-11.3). 16 November 1992.

- FM 3-3-1. *Nuclear Contamination Avoidance*. 9 September 1994.
- FM 3-5. *NBC Decontamination* (will be revised as FM 3-11.5). 28 July 2000.
- FM 3-20.98 (FM 17-98). *Reconnaissance Platoon*. 2 December 2002.
- FM 3-52 (FM 100-103). *Army Airspace Command and Control in a Combat Zone*. 1 August 2002.
- FM 3-90 (FM 100-40). *Tactics*. 4 July 2001.
- FM 3-100.2 (FM 100-103.1). *ICAC2 - Multiservice Procedures for Integrated Combat Airspace Command and Control*. 30 June 2000.
- FM 3-100.4. *Environmental Considerations in Military Operations* (will be revised as FM 4-04.4). 15 June 2000.
- FM 3-100.12. *Risk Management Multiservice Tactics, Techniques, and Procedures for Risk Management*. 15 February 2001.
- FM 4-0 (FM 100-10). *Combat Service Support*. 29 August 2003.
- FM 4-30.3 (FM 9-43.1). *Maintenance Operations and Procedures*. 28 July 2004.
- FM 5-0 (FM 101-5). *Army Planning and Orders Production*. 20 January 2005.
- FM 6-0 (FM 101-5). *Mission Command: Command and Control of Army Forces*. 11 August 2003.
- FM 6-30. *Tactics, Techniques, and Procedures for Observed Fire* (will be revised as FM 3-09.3). 16 July 1991.
- FM 11-55. *Mobile Subscriber Equipment (MSE) Operations*. 22 June 1999.
- FM 12-6. *Personnel Doctrine* (will be revised as FM 1-0). 9 September 1994.
- FM 34-130. *Intelligence Preparation of the Battlefield* (will be revised as FM 2-01.3). 8 July 1994.
- FM 44-8. *Combined Arms for Air Defense* (will be revised as FM 3-01.8). 1 June 1999.
- FM 90-4. *Air Assault Operations* (will be revised as FM 3-18.12). 16 March 1987.
- FM 90-20. *JAAT Multiservice Procedures for Joint Air Attack Team Operations*. (will be revised as FM 3-09.33). 3 June 1998.
- FM 100-14. *Risk Management* (will be revised as FM 5-19). 23 April 1998.
- FM 100-15. *Corps Operations* (will be revised as FM 3-92). 29 October 1996.
- FM 101-5-2 (FM 3-99.2). *U.S. Army Report and Message Formats*. 29 June 1999.
- Fleet Marine Force Manual (FMFM) 3-42-1. *Unmanned Aerial Vehicle Company Operations*. 14 August 2003.
- JP 1-02. *Department of Defense Dictionary of Military and Associated Terms*. 12 April 2001 (As Amended Through 31 August 2005).
- JP 3-0. *Joint Operations*. 23 December 2005.
- JP 3-09.3. *Joint Tactics, Techniques, and Procedures for Close Air Support (CAS)*. 3 September 2003.

References

- JP 3-52. *Joint Doctrine for Airspace Control in the Combat Zone*. 30 August 2004.
- JP 3-55. *Doctrine for Reconnaissance, Surveillance, and Target Acquisition Support for Joint Operations (RSTA)*. 14 April 1993.
- JP 3-60. *Joint Doctrine for Targeting*. 17 January 2002
- JP 4-0. *Doctrine for Logistic Support of Joint Operations*. 6 April 2000.
- JP 4-03. *Joint Bulk Petroleum and Water Doctrine*. 23 May 2003.
- ST 2-19.602/3-20.972. *Surveillance Troop*. 31 January 2003.
- STANAG 2936. *Intelligence Doctrine (AintP-1[A])*. 10 July 1997.
- STP 34-96U14-SM-TG. *Soldier's Manual and Trainer's Guide for MOS 96U Tactical Unmanned Aerial Vehicle Operator Skill Levels 1, 2, 3, and 4*. 29 March 2004.
- TC 1-210. *Aircrew Training Program Commander's Guide to Individual and Crew Standardization*. 3 October 1995. Change 1, 8 January 1996.
- TC 34-212. *Unmanned Aerial Vehicle Aircrew Training Manual*. December 2002.
- U.S. Army Center for Lessons Learned Newsletter No. 99-9, *Integrating Military Environmental Protection*. September 1999.
- U.S. Army Center for Lessons Learned Newsletter No. 00-5, *Aviation Operations at the Joint Readiness Training Center*. Chapter 3. Light-Army Aviation at the JRTC: Do We Perform Search and Attack? March 2000.
- U.S. Army Combat Training Center Quarterly Bulletin No. 99-3. *The Dying Art of Battle Rhythm*. LTC Gene C. Kamena. January 1999.
- U.S. Army Readiness Center. *Commander and Staff Risk Management Booklet*. 6 January 1999.
- U.S. Army Readiness Center. *Small Unit Risk Management Booklet*. 6 January 1999.

Index

A

actions on the objective, 4-8, 4-19, 5-4

administrative and logistics operations center (ALOC), A-4

advanced field artillery tactical data system (AFATDS), 2-6, 4-22, D-3

aerial reconnaissance, 5-3

aerial vehicle (AV), vi, 4-23

air assault, 5-10, 5-11, 5-12 planning, 5-10

air control order (ACO), 3-1, 4-12, 4-16, 4-21, A-2, A-10, B-1, B-3, B-5, B-9, B-20

air control point (ACP), A-2, B-14, B-15

air defense (AD), 1-3, 3-2, 3-4, 5-17, B-1, B-6, B-9

air defense and airspace management (ADAM), B-4, B-5, B-6, B-7, B-8, B-9, B-14, B-16

air defense artillery (ADA), 4-6, 5-8, A-1, B-4

air liaison officer (ALO), E-1

air missile defense (AMD), B-5

air mission brief (AMB), 4-17

air mission commander (AMC), 1-14, 4-10, 4-16, 4-17, 4-18, 4-19, 5-4, 5-6, 5-32, A-8

air movement, B-2

air support operations center, 5-30

air tasking order (ATO), 3-1, 3-2, 3-3, 4-12, 4-16, 4-21, A-2, B-5, B-9, D-1

air traffic control (ATC), 3-7, A-4, B-1, E-1, E-4

air traffic services (ATS), B-2, C-2

air vehicle transport (AVT), 1-10, 6-5

airborne warning and control system (AWACS), 3-6, 4-12, 5-30

aircraft recovery, A-11

aircrew training manual (ATM), 1-5, C-2

aircrew training program (ATP), C-1

air-ground integration, C-2

airspace control area, B-2

airspace control point (ACP), B-2

airspace coordinating measure (ACM), 4-12, 4-16, 4-21, 5-29, A-6, A-10, B-2, B-18, B-20

airspace coordination area (ACA), 3-2, 4-20, 4-21, 5-28, B-1, B-2, B-9

area air defense commander (AADC), 3-2

area of interest, 4-13, 4-25

area of operations contiguous, 1-5 noncontiguous, 1-5, 4-1, 5-10, B-14

area of operations (AO), 4-1, 4-5, 4-9, 4-11, 5-19, A-10, B-9

area of responsibility (AOR), B-3, B-9, B-11, B-12, B-14

area reconnaissance, 5-12

area security, 4-2, 5-6, 5-7, 5-9, 5-10

Army airspace command and control (A2C2), 1-5, 4-12, 4-20, 4-21, A-7, B-1, B-4, B-5, B-8; tasks, B-6

Army airspace command and control system (A2C2S), 1-1, 5-1

Army battle command system (ABCS), 2-7, 4-22, B-4, B-6, D-2

Army forces (ARFOR), 3-3

Army tactical missile system (ATACMS), B-3

assault helicopter, 5-11

assembly area (AA), 1-12, 4-13, 5-11, 5-14, 5-18, 5-21

Assistant Chief of Staff, Operations and Plans (G3), 4-12, B-7, B-8, C-5, C-6

attack operations hasty attack, 5-23

avenues of approach, 5-6, 5-7, 5-20

aviation mission planning system (AMPS), 4-3

B

battle damage assessment (BDA), 1-1, 1-2, 1-8, 1-9, 1-10, 1-12, 2-7, 3-13, 3-14, 4-2, 4-19, 5-1, 5-12, 5-14, 5-17, B-8, D-2

battle handover (BHO), 5-8

battle position (BP), 4-13, 5-12, B-2

battle staff, 4-15

battlefield operating system (BOS), 4-1, B-1

Blue Force Tracking (BFT), 4-3, 5-3, B-6

brigade aviation element (BAE), 4-12, B-4, B-5, B-6, B-7, B-8, B-9, B-14, B-16

brigade aviation officer (BAO), 4-11, B-5

brigade combat team (BCT), 1-6, 4-12, 4-13, B-2, B-3, B-4, B-5, B-6, B-7, B-8, B-9, B-11, B-12, B-14

C

call sign, A-2, B-10

chemical, biological, radiological, and nuclear (CBRN), 1-5, 5-1, A-2

close air support (CAS), 4-15, 4-21, 5-13, 5-18, 5-27, 5-28, B-7

close combat attack (CCA), 4-15

Coast Guard, 3-20

combat missions, 4-13

combat search and rescue (CSAR), A-10

combat service support (CSS), 6-1

combined arms training strategies (CATS), C-2

command and control (C2),
1-3, 5-9, 5-17, 5-28, 6-1,
B-1, C-3, D-1;
system, 1-1, D-2

command relationships, 4-8

command, control, and
communications (C3), 4-3

command, control,
communications, computers,
and intelligence (C4I), D-1

command, control,
communications, computers,
intelligence, surveillance,
reconnaissance (C4ISR),
3-21

commander

- air mission (AMC), 1-14,
4-10, 4-16, 4-17, 4-18,
4-19, 5-4, 5-32, A-8
- joint force (JFC), 3-1, 3-2,
3-3, 3-8
- joint force air component
(JFACC), 3-1, 3-2, 3-3,
3-8, 4-20, 5-30, B-9, D-3
- mission (MC), 1-13

commander's critical
information requirement
(CCIR), 4-1, 4-9, 4-21

common ground station (CGS),
2-6, 4-13, 4-22

common operating picture
(COP), 1-1, 5-1

communications relay package
(CRP), 5-14

communications security
(COMSEC), 4-24, A-4, B-19

coordinating altitude, 1-6, B-3,
B-7, B-9

counterattack, 5-14

course of action (COA), 5-6,
B-7, B-8

cover and concealment, 5-9

covering force, 5-7, 5-17

D

deception operation, 1-2

decisive operation, 4-15, 5-3

decontamination, 1-5

deep area, 4-8

Desert Hawk UAVS, 3-10, 3-12

downed aircraft recovery team
(DART), A-10

Dragon Eye UAVS, 3-16, 3-17

E

Eagle Eye UAVS, 3-20, 3-21

effects coordinator (ECOORD),
4-11

electronic intelligence (ELINT),
3-5

electronic warfare (EW), 5-1,
A-2, A-4

emergency procedures, 4-26

engagement area (EA), 4-8

F

FalconView, 2-12

field maintenance, 6-6

Fire Scout UAVS, 3-13, 3-14

fire support (FS), 1-3, 4-8,
4-13, 5-26, B-1, B-7

fire support coordinating
measure (FSCM), 4-12,
5-28, 5-30

fire support coordination line
(FSCL), 5-30

fire support element (FSE),
4-14, 5-14, B-3

fire support officer (FSO), B-7,
B-10

fires

- indirect, 1-8, 1-10, 1-12,
2-11, 4-8, 5-2, 5-7, 5-8,
5-9, 5-11, 5-14, 5-15,
5-26, 5-28, B-4, B-8

fires and effects cell (FEC),
2-6, 5-7, 5-13, B-4, B-5,
B-16, D-2

flight modes, 2-11, 4-13

force protection, 4-29, 5-32

force XXI battle command
brigade and below (FBCB2),
5-1, B-6

forward arming and refueling
point (FARP), 5-7, 5-8, 5-20,
5-22, B-2

forward line of own troops
(FLOT), 1-2, 4-2, 5-12

forward operating base (FOB),
5-10, B-10, B-11, E-7

forward support battalion
(FSB), 6-4, 6-5

forward-looking infrared (FLIR),
2-9, 5-12

fragmentary order (FRAGO),
4-8, 4-9, 4-18, A-2, A-8

fratricide, 5-3, B-3, B-5

G

Global Command and Control
System (GCCS), D-2

Global Hawk UAVS, 3-4, 3-5,
3-6, 4-12

global positioning system
(GPS), 2-7, 2-11, 3-5, 3-7,
3-11, 3-15, 3-16, 3-18, B-17,
E-5

ground control station (GCS),
vi, 1-1, 1-7, 1-8, 1-10, 2-5,
2-6, 2-9, 2-11, 3-3, 3-6, 3-7,
3-8, 4-3, 4-21, 4-23, 5-1,
5-5, 5-11, 6-5, A-8, A-10,
D-2

ground data terminal (GDT), vi,
1-7, 1-8, 1-10, 2-11, 3-4, 3-7,
4-4

ground support equipment
(GSE), 1-7, 4-3

ground surveillance radar
(GSR), 4-13, 5-10

ground tactical plan, 5-10,
5-12

H

hasty attack, 5-23

hazardous material (HAZMAT),
E-1, E-3

high-payoff target (HPT), 4-15,
4-19, 5-17, 5-18

high-value target (HVT), 4-13

Hunter UAVS, 1-1, 1-7, 1-14,
2-2, 2-3, 2-5, 2-6, 4-10,
4-12, 4-23, 5-14, 6-1, 6-3,
6-4, A-4, C-3, C-4, D-1, D-2,
E-6

- aerial reconnaissance
company, 1-8, 4-12

I

identification friend or foe (IFF),
4-12, 4-21, A-6, B-2, B-3,
E-1

I-Gnat UAVS, 1-1, 1-7, 2-1,
4-10, 4-23, 6-4

imagery intelligence (IMINT),
3-13

indirect fires, 1-8, 1-10, 1-12,
4-8, 5-2, 5-7, 5-8, 5-9, 5-14,
5-15, 5-26, 5-28, B-8

infrared (IR) crossover, 5-20

instructor pilot (IP), 1-14, C-1,
C-2

instrument meteorological
conditions (IMC), A-10

intelligence & electronic
warfare (IEW), 5-17

- intelligence officer (S2), 1-14, 4-1, 4-11, 4-13, 4-14, 4-15, B-7
- intelligence preparation of the battlefield (IPB), 1-4, 5-7
- intelligence report (INTREP), 5-5
- intelligence, surveillance, and reconnaissance (ISR), 1-1, 1-7, 1-8, 1-9, 1-10, 2-3, 3-1, 3-5, 3-20, 3-21, 4-1, 4-13, 4-14, 4-15, 5-7, 5-9, 5-10, D-1
- J**
- joint air attack team (JAAT), 4-17
- joint force air component commander (JFACC), 3-1, 3-2, 3-3, 3-8, 4-20, 5-30, B-9, D-3
- joint force commander (JFC), 3-1, 3-2, 3-3, 3-8
- joint suppression of enemy air defense (J-SEAD), 4-8, 4-13
- joint surveillance target attack radar system (JSTARS), 2-6, 3-6, 4-13, 4-15
- joint task force (JTF), 3-1, 3-3, B-5
- joint, interagency and multinational (JIM), v
- L**
- landing zone (LZ), 5-12
- laser range finder/designator (LRF/D), 2-7, 4-8
- launch and recovery, 1-14
- launch and recovery (L/R), vi, 2-5, 4-3, 4-6, 4-23, 4-30, B-3, B-10, B-15
- liaison officer (LNO), 3-2, 3-3, 3-4, 4-1, 4-9, 4-11, 4-14, D-3
- line of sight (LOS), 2-4, 2-9, 2-14, 3-6, 3-7, 4-21, 5-14, A-3, A-4, A-6, A-11, B-18
- local area network (LAN), 4-24
- logistics officer (S4), 6-3
- M**
- main supply route (MSR), 5-9, 5-10
- maintenance officer, 1-13
- major theater war (MTW), 5-7
- military intelligence (MI), 2-6, 4-22, 5-5, 5-18
- mission essential task list (METL), 1-14, C-2
- mission planning, 3-3, 3-4, 3-6, 4-3, 4-5, 4-8, 4-9, 4-17, 4-28, 5-9, A-1, A-6, A-7, B-18
- mission training plan (MTP), 1-5, C-2
- mobile subscriber equipment (MSE), 4-24
- movement techniques, 4-14
- movement to contact, 5-23
- moving target indicator (MTI), 2-7, 3-5, 4-13
- multi-spectral targeting system (MTS), 3-7, 3-9
- N**
- named area of interest (NAI), 4-13, 4-14, 4-15, 4-18, 5-6, A-3, B-17, B-18
- nap-of-the-earth (NOE), 1-5
- naval surface fire support (NSFS), 3-14
- navigational aid (NAVAID), B-2
- no-fire area (NFA), 5-28
- non line-of-sight (NLOS), 1-7
- nonlethal, 5-19
- notice to airmen (NOTAM), 4-16, A-7
- O**
- observation post (OP), 4-14, 5-7, 5-8, 5-9, 5-10, 5-19, 5-21, 5-22, A-8
- observer controller (OC), C-2
- offensive operations, 4-14, 5-7
- on-call fire, 5-13, 5-19
- operating tempo (OPTEMPO), 4-1
- operation order (OPORD), A-2, A-8
- operations
 - countermobility, 1-3
 - deception, 1-2
 - decisive, 4-15, 5-3
 - offensive, 4-14, 5-7
 - security, 1-5, 3-21, 5-6
 - stability, 4-10
 - support, 4-10, 5-1
 - urban, B-3, B-9, B-15
- operations officer (S3), 1-13, 1-14, 4-1, 4-11, 4-29, B-4, B-5, B-6, B-7, B-8, B-10, B-16, B-20, C-5, C-6
- operations security (OPSEC), 4-4, A-4
- P**
- passage of lines, 5-12
- passage point (PP), 4-13, 5-11, 5-14
- personnel recovery (PR), 5-30, 5-31, 5-32
- petroleum, oil, and lubricants (POL), 6-4, 6-5
- Pioneer UAVS, 3-13
- planning
 - process, 4-1, 4-9, 4-12, 4-15, 4-20
 - responsibilities, 4-12, 4-13
- Pointer UAVS, 3-15, 3-23
- precombat inspections (PCI), B-17, B-19
- Predator B UAVS, 3-9
- Predator UAVS, 3-6, 4-12
- preventive maintenance checks and services (PMCS), 6-3
- priority intelligence requirement (PIR), 4-9, 4-10, 4-11, 4-13, 4-17, B-17
- production control, 1-8
- Q**
- quality assurance (QA), 6-4, 6-5, E-4
- quick reaction force (QRF), B-10
- R**
- Raven UAVS, 1-1, 1-3, 1-5, 2-11, 2-12, 2-13, 2-14, 3-24, 4-3, 4-10, 4-24, 6-1, 6-6, A-3, A-4, A-11, D-1, E-6, E-7, E-8
- team, 1-11, 1-12
- reaction force, 5-8, 5-22
- rear area, 4-3, 5-6, 5-9, 5-10
- reconnaissance
 - aerial, 5-3
 - area, 5-12
 - in force, 5-2
- reconnaissance and security, 1-8, 1-10, 4-14, 5-17
- reconnaissance and surveillance (R&S), 1-12, 2-11, 3-1, 4-16, 4-18, 5-1, 5-10, 5-14, 5-17, 5-18

reconnaissance, security, and target acquisition (RTSA), 3-2, 4-14, B-8, D-1, D-2
release point (RP), 4-18, 4-19, 5-4
restricted operations area (ROA), 4-20, 5-28, A-2, A-7, B-3, B-4, B-10, B-11, B-13, B-14, B-18
restricted operations zone (ROZ), 4-7, 4-13, 4-20, 4-21, A-2, A-7, B-3, B-4, B-18, B-20
risk management, 4-26, 4-27, 4-28, 4-29
rules of engagement (ROE), 4-7, 5-28, A-2

S

safety officer (SO), 4-29, C-2
satellite communications (SATCOM), 3-4, 3-5, 3-6, 3-7, 3-8, 4-25
Scan Eagle UAVS, 3-18, 3-20
scheme of maneuver, 1-8, 1-9, 2-10, 4-9, 4-12, A-2, B-2, B-5
security
 area, 4-2, 5-6, 5-7, 5-9, 5-10
 mission, 4-2, 5-6, 5-7
security operation, 1-5, 3-21, 5-6
semi-active laser (SAL), 3-8
Shadow UAVS, 1-1, 1-3, 1-6, 1-14, 2-7, 2-8, 2-9, 2-10, 4-10, 4-24, 6-1, 6-3, 6-5, A-4, C-3, D-1, D-2, E-3, E-4, E-5, E-6
 aerial reconnaissance platoon, 1-9, 2-10, 4-4
signal intelligence (SIGINT), 3-5, 4-2, 4-12, 4-13

signal operation instructions (SOI), A-7
Silver Fox UAVS, 3-17, 3-18
single channel air-ground radio system (SINCGARS), 4-24
situation report (SITREP), A-8
situational awareness (SA), 1-1, 1-7, 1-9, 1-10, 1-12, 3-15, 4-15, 5-1, 5-4, 5-27, 5-28, 5-32, B-5, B-8, B-9
situational understanding (SU), 5-1, B-5
Snow Goose UAVS, 3-22, 3-23
special instructions (SPINS), 4-17, 4-21, 5-28, A-2, A-7, A-10
stability operation, 4-10
staging plan, 5-10
standard use Army aircraft flight route (SAAFR), B-14
standardization instructor pilot (SP), 1-14, C-1, C-2
standing operating procedure (SOP), 4-8, 4-29, 5-3, 5-17, B-2, B-17
stationary screen, 5-9
Stryker brigade combat team (SBCT), 1-10, 5-6, B-5
support operation, 4-10
suppression of enemy air defense (SEAD), 4-13
surface-to-air missile (SAM), 3-11, 4-7
sustainment maintenance, 6-5

T

tactical airspace integration system (TAIS), B-4, B-6, B-7
tactical area of interest (TAI), 4-13, 5-6

tactical common data link (TCDL), 2-8
tactical internet (TI), A-8
tactical operations center (TOC), 4-3
tactical standing operating procedure (TACSOP), A-10
tactics, techniques, and procedures (TTP), v, 1-13, 5-17, B-9, C-4
target acquisition (TA), 1-2, 1-8, 1-9, 1-10, 1-12, 2-7, 3-5, 3-8, 3-13, 3-20, 4-2, 4-14, 5-8, 5-12, 5-13, 5-17, D-2
targeting, 3-2, 3-15, 4-13, 4-15, 4-16, 5-1, 5-3, 5-4, 5-12, 5-14, D-2, D-3
terrain flight, 5-8
 nap-of-the-earth, 1-5
transformation force, v
Trojan Spirit, 3-4, 3-7, 4-14
troop leading procedures (TLP), B-17

U

urban operation, B-3, B-9, B-15

V

visual flight rules (VFR), C-4
visual observation, C-4

W

warning order (WARNO), 4-8, 4-16, A-2, A-6, A-8, B-17
weather, 4-5, 4-6, 5-1, E-3

FMI 3-04.155
4 April 2006
Expires 4 April 2008

By Order of the Secretary of the Army:

Official:



JOYCE E. MORROW
*Administrative Assistant to the
Secretary of the Army*

0607302

PETER J. SCHOOMAKER
*General, United States Army
Chief of Staff*

DISTRIBUTION:

Active Army, Army National Guard, and U.S. Army Reserve: Not to be distributed. Electronic media only.

